

# **Fusion 550**

Owner's Manual



# Fusion 550 Bass Amplifier

## Congratulations

Your purchase of a new Gallien-Krueger amplifier is surely the result of much careful consideration on your part. For our part, we at Gallien-Krueger are pleased that you chose us, and are determined that you will be a satisfied customer. In choosing GK, you now own an amplifier with many unique features which will allow you to create your own distinct sound.

To get the most out of your new amplifier please take a few minutes to read through this manual. If you are in a hurry, we suggest you at least read through the Quick Start section before setting up your new rig. This will help get you started and give you a few quick tips, but is not a substitute for reading the rest of the manual.

Your amplifier should have come with the following items, please check the contents of the box to ensure that you have everything.

Power cord	1
RF-II Footswitch	1
Balanced 20' Patch Cable	1
Owner's manual	1
Warranty card	1
Safety instructions sheet	1

If your amplifier did not come with all the items listed, or if you encounter problems while setting up your new equipment, please contact your local dealer or GK as soon as possible.

Gallien-Krueger, Inc.  
2234 Industrial Drive  
Stockton, CA 95206  
phone: (209) 234-7300  
fax: (209) 234-8420  
Internet: [www.gallien-krueger.com](http://www.gallien-krueger.com)  
Email: [info@gallien.com](mailto:info@gallien.com)



## Always Listening

I have never seen the point in doing things the way others have done them. I also have not been very interested in following the latest fad. I'm a Stanford educated engineer who worked my way through school as a musician. Like all musicians, I have lugged amplifiers up stairways and into car trunks, always wondering why these things had to be so heavy, bulky, and hard to handle.

As I am the principal innovator at GK, our products reflect my attitudes and life experiences. I don't model my designs after other manufacturers' products. Instead, I believe these problems are best solved with new solutions. Having taken our own path, GK products enjoy a unique, unmatched sound, allowing you every opportunity to make an original statement with your music.

Having supported my products for over thirty years, I have learned from the story they tell. Gallien-Krueger is a reflection of that story, and has a commitment to support that legacy. Just as the products I created over thirty five years ago are still telling their story, the products we create today will be spreading the word for years to come.

We'll be listening,





**Robert Gallien**

## Table Of Contents

<b>Safety Information</b> .....	<b>4</b>
<b>Quick Start</b> .....	<b>5</b>
<b>Front Panel Controls</b> .....	<b>6</b>
<b>Rear Panel Controls</b> .....	<b>7</b>
<b>Horn Bi-Amp System</b> .....	<b>8</b>
<b>Sample Settings</b> .....	<b>9</b>
<b>Tech Talk</b> .....	<b>10</b>
<b>Specifications</b> .....	<b>12</b>

### Warning!

**This amplifier is capable of producing high sound pressure levels. Continued exposure to high SPL's can cause damage to your hearing. Always set the volume at a safe listening level or use hearing protection if the unit is operated at higher levels.**

	<b>CAUTION</b> RISK OF ELECTRIC SHOCK DO NOT OPEN	
<b>CAUTION: TO REDUCE THE RISK OF ELECTRIC SHOCK, DO NOT REMOVE COVER. NO USER SERVICEABLE PARTS INSIDE. REFER SERVICING TO QUALIFIED SERVICE PERSONNEL.</b>		
	The lightning flash with arrow head symbol, within the equilateral triangle, is intended to alert the User to the presence of uninsulated "dangerous voltage" within the product enclosure that may be of sufficient magnitude to constitute risk of electric shock to persons.	
	The exclamation point within the equilateral triangle, is intended to alert the User to the presence of important operating and maintenance (servicing) instructions in the literature accompanying the appliance.	
<b>WARNING: TO REDUCE THE RISK OF FIRE OR ELECTRIC SHOCK, DO NOT EXPOSE THIS APPLIANCE TO RAIN OR MOISTURE</b>		
<b>CAUTION: TO PREVENT ELECTRIC SHOCK, MATCH WIDE BLADE OF PLUG TO WIDE SLOT, FULLY INSERTED.</b>		
<b>ATTENTION: POUR EVITER LES CHOCS ELECTRIQUES, INTRODUIRE LA LAME LA PLUS LARGE DE LA FICHE DANS LA BORNE CORRESPONDANTE DE LA PRISE ET POUSSER JUSQU'AU FOND.</b>		

## Safety Information

**Please read all enclosed safety precautions before connecting or operating this product.**

**Verify Line Voltage and Amperage:** Your new amplifier has been factory configured for use with the following:

- 120 Volt/60Hz 15 A circuit for USA/Canada.
- 240 Volt/50Hz 10 A circuit for UK/Australia.
- 230 Volt/50Hz 10 A circuit for Europe.
- 100 Volt/50Hz 15 A circuit for Japan.
- 220 Volt/50Hz 10 A circuit for Korea.

**Verify AC Circuit Capacity Before Use:** The high power output of your amplifier may require heavy current draw under full-load conditions. Connecting the amplifier to a line with specifications other than indicated above can create a safety or fire hazard and may damage the amplifier. Connecting to the same circuit used by other heavy-power devices, such as high-wattage lights, may cause circuit breakers to trip. It is always a good idea to avoid using any audio equipment on the same AC circuit as equipment with motors, such as air conditioners or refrigerators. This will lessen the possibility of power variation and electrical start-up noise affecting your sound.

**AC Power Cord:** To avoid safety hazards, use only the power cord supplied with your unit. If a replacement cord is needed, make certain to use a standard IEC compliant cord. Damaged power cords should be replaced immediately. When setting up, make certain that the AC plug is easily accessible. If you do not intend to use the amplifier for a considerable length of time, disconnect the plug from the AC Mains Socket.

**Earth Ground Connection:** To prevent electric shock, do not remove the grounding plug on the power cord, or use any plug or extension cord that does not have a grounding plug provided. Make certain that the AC outlet is properly grounded as well. Do not use an adapter plug with this product.

**Do Not Open the Amplifier Enclosure:** There are no user-serviceable parts inside this product. Opening the amplifier enclosure may present a shock hazard. Modification to the product will void your warranty. If liquid enters the unit, or any metal object such as a paper clip accidentally falls inside the enclosure, disconnect the unit from the AC power source immediately and consult an authorized service station.

**Setup:** To insure proper operation and to avoid potential safety hazards, place the unit on a firm, level surface. Do not plug or unplug the instrument or speaker cable while the amplifier power is on.

**Heat & Ventilation:** Air flows from back to front of the unit, make sure there is at least 8 inches of clearance on top, sides and back of the amplifier, in the event that the unit is rack mounted, maintain an 8" clearance on the back and front of the unit, 1.75" or one rack space on top and bottom. Avoid using in extremely hot or cold locations and areas that are exposed to direct sunlight or near heating equipment. Avoid using in moist or high humidity areas.

**Cleaning & Maintenance:** Clean only with dry cloth. Never use benzene, thinner, alcohol, or other volatile cleaning agents. Do not use abrasive cleaners, as they may damage the finish of metal parts. Avoid spraying insecticides near the unit. No other maintenance should be necessary.

**Traveling:** If Traveling with the unit frequently, we recommend a road case or cover to protect it from scratches and road wear.

**Packaging:** The carton and packing materials used in shipping your new amplifier were specifically designed to cushion it from the shocks and vibration that occur during transport. We suggest that you save the carton and packing materials for use in shipping, in the event you move, or if the amplifier needs repair.

## Quick Start

**Plug It In:** Set the power switch to Off and connect the supplied power cord to the amplifier's AC receptacle and an AC power outlet of proper voltage (see safety information on page 4 for details).

**External Cabinets:** If using an external speaker cabinet, connect it to the free speaker output. If you are using two 8 ohm or one 4 ohm external cabinet with a combo amplifier, disconnect the internal speaker. Be sure not to exceed the recommended speaker load below.

### Maximum Recommended Speaker Loads:

EXTERNAL SPEAKER(S)	TOTAL LOAD
1 x 8 ohm	8 ohms
1 x 4 ohm	4 ohms
2 x 8 ohm	4 ohms

*Note: If you are using a GK Horn Bi-Amp compatible speaker cabinet, set it to Bi-Amp using the switch on the back of the cabinet. (See Page 8 for more details on GK's Horn Bi-Amp System)*

**Initial Front Panel Control Settings:** Set all active equalizer controls and contour to 12 o'clock, and the bright and deep switches off. Set the Gain and Master Volumes to 0.

**Connect Your Bass:** Using an instrument (shielded) cable, connect your bass to the Input jack and press the power switch on.

**Input and Master Volume Settings:** Set the master to 12 o'clock then gradually increase the Gain control to a comfortable listening level. If using a passive bass, set input switch to passive. With an active bass, it maybe necessary to set the input attenuator switch to active. This is only required with very high output active basses resulting in distortion from over driving the input stage.

# Fusion 550 Bass Amplifier

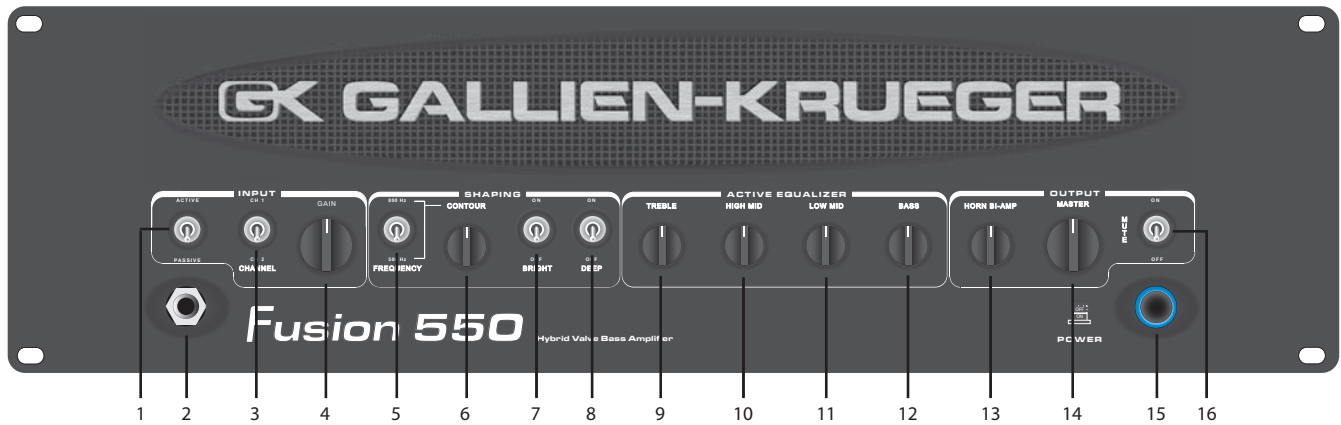

## Front Panel Features

**1) Active/Passive Switch:** Reduces the input signal from your bass by -10dB. Choose Active for basses with active electronics and very high output.

**2) Input Jack:** A standard 1/4" input jack to plug in active or passive basses using an instrument (shielded) cable.

**3) Channel Select Switch:** Allows you to store two different settings via the motorized knobs. Switch to Channel 1 and adjust your settings then switch to Channel 2 and adjust the settings for your second channel.

**4) Gain:** Sets the preamp volume level before the shaping filters and EQ section.

**5) Frequency Select Switch:** Sets the center frequency for the Contour control to either 500Hz or 800Hz.

**6) Contour:** Reshapes the voice of the amplifier by cutting mid frequencies at either 500Hz or 800Hz depending on the position of the Frequency Select Switch.

**7) Bright:** Boosts higher frequencies.

**8) Deep:** Boosts lower frequencies.

**9) Treble:** Active shelving type control which boosts and cuts the high frequencies.

**10) High Mid:** Active bandpass type control which boosts and cuts at about 1kHz..

**11) Low Mid:** Active bandpass type control which boosts and cuts at about 250Hz.

**12) Bass:** Active shelving type control which boosts and cuts the low frequencies.

**13) Horn Bi-Amp:** Sets the ratio between the horn output and the master output.

**14) Master:** Master volume control.

**15) Power & LED:** Power on/off switch and LED. The LED ring is blue when the amplifier is on and flashes when the amplifier is muted via the Mute switch. If there is an electrical fault (shorted output, over heat) the protection circuitry will be engaged muting the amplifier output and the LED ring will turn red.

**16) Mute:** Mutes the master and DI output of the amplifier. The Tuner output is not affected. LED ring will flash blue when the amplifier is muted.

# Fusion 550 Bass Amplifier

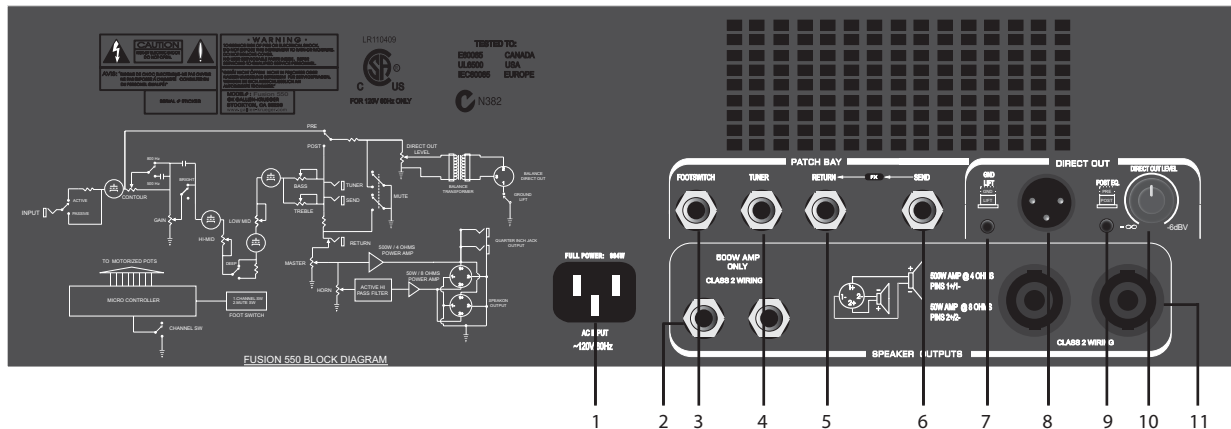

## Rear Panel Features

**1) AC Receptacle:** Standard IEC Receptacle. The power cord plugs in here.

**2) 500W Amp Only:** ¼" speaker output jacks. Impedances Lower than 4 Ohms should not be used. Higher impedances such as 8 Ohms, 16 Ohms, or No Load are acceptable. One 4 Ohm, or 8 Ohm, or two 8 Ohm cabinets are okay. One 4 Ohm and one 8 Ohm together is not recommended. No damage will result from operating the amplifier with the speakers disconnected.

**3) Footswitch:** ¼" jack for standard 2-pole latching footswitch. Switches between Channels and activates the Mute.

**4) Tuner Out:** Comes directly off of the input stage. Unaffected by the Mute button or any of the preamp functions.

**5) Effects Return:** Returns the Effects Loop signal to the signal path in series with the preamp signal. The preamp signal will be interrupted when the Return jack is used.

**6) Effects Send:** Provides access to the preamp signal for putting effects into the signal path. May also be used to drive other amplifiers. The signal to the power amp is not interrupted when the send jack is used.

**7) Ground/Lift:** Used to eliminate hum when connecting to equipment that is running on a different ground system.

**8) Balanced Direct Out:** A transformer-balanced low impedance output to run directly to the PA system via a 3-pin XLR cable.

**9) Pre/Post EQ:** Takes the Direct Out signal from before or after the EQ section.

**10) Direct Out Level:** Controls the output level of the Direct Out signal.

**11) Speakon Outputs:** High current twist-lock Speakon output connectors. Pins 1+ and 1- send a fullrange signal from the Main (Woofer) amplifier. Pins 2+ and 2- send a signal 5kHz and above from the Horn amplifier. Use a four-conductor Speakon cable when connected to a GK Horn Bi-Amp compatible speaker cabinet. Use a standard two-conductor Speakon cable when connected to a non-GK cabinet or if you're using a Speakon to ¼" adapter.

# Fusion 550 Bass Amplifier

## Horn Bi-Amp System (HBS):

Your amplifier incorporates GK's unique HBS. This feature is automatically engaged when you connect to a GK HBS compatible enclosure, giving you independent control of the tweeter and woofer signals. Now you can push the woofers to the max while the tweeter remains clean, crisp, and free of clipping distortion. A smooth tight tone is easily dialed in by adjusting the Horn and Woofer Master controls on the amplifier's front panel.

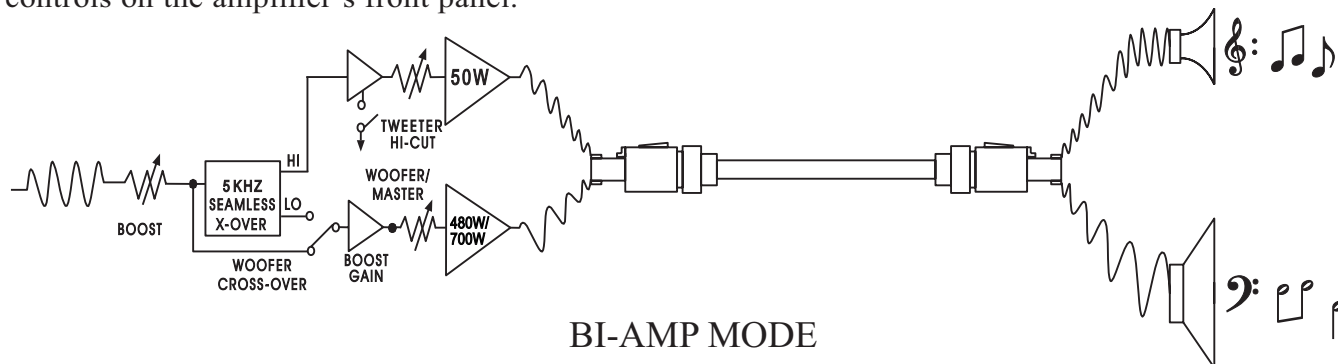

BI-AMP MODE

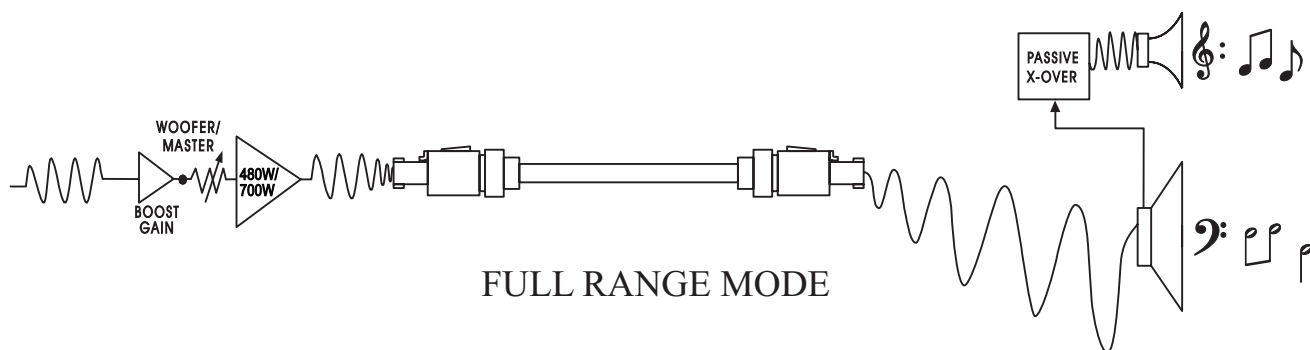

FULL RANGE MODE

**Horn Bi-Amp Mode:** This mode requires a GK Horn Bi-Amp compatible bass cabinet. Use a properly wired four-conductor Speakon cable to connect to your cabinet. Set the switch on the back of your GK HBS compatible enclosure to Bi-Amp. In this mode, the cabinet's internal crossover is bypassed. Use the Woofer/Main knob to control the output signal to the woofer, and the Horn knob to control the output signal to the horn.

*Note: The 50W horn amplifier has a fixed frequency output of 5kHz and up (high frequencies only). It will not provide a usable signal to drive a separate speaker cabinet.*

### GK Speakon Cable Wire Configuration:

- 1+ Woofer Amp +
- 1- Woofer Amp -
- 2+ Horn Amp +
- 2- Horn Amp -

**Full range Mode:** This mode is compatible with virtually any standard bass cabinet. Use a two-conductor Speakon cable or a 1/4" speaker cable to connect to your cabinet. If using a GK HBS compatible enclosure, set the switch on the back of the cabinet to Full range. In this mode, the cabinet's internal passive crossover is used to split the signal between the woofer and horn. Use the Woofer/Main knob on the front of the amplifier to control your output level. The Horn knob is not used.

*Note: To avoid the risk of damage to the amplifier, do not use a four-conductor Speakon cable with non GK cabinets. Instead use a two-conductor Speakon or 1/4" speaker cable.*

**CAUTION: UNDER NO CIRCUMSTANCES SHOULD THE WOOFER/MAIN AMP AND THE 50 WATT HORN AMP BE CONNECTED TOGETHER!!!**

# Fusion 550 Bass Amplifier

## Sample Settings:

Your GK amplifier is versatile in its sound and tone. Below are a few suggested amp settings that can be used as starting points to define your own sound.

*Note: At higher playing levels the contour should be set lower for mid-range clarity. To get 800RB voicing, the contour should be set to 0 or 10 only.*

### Slap:

Both pickups recommended.

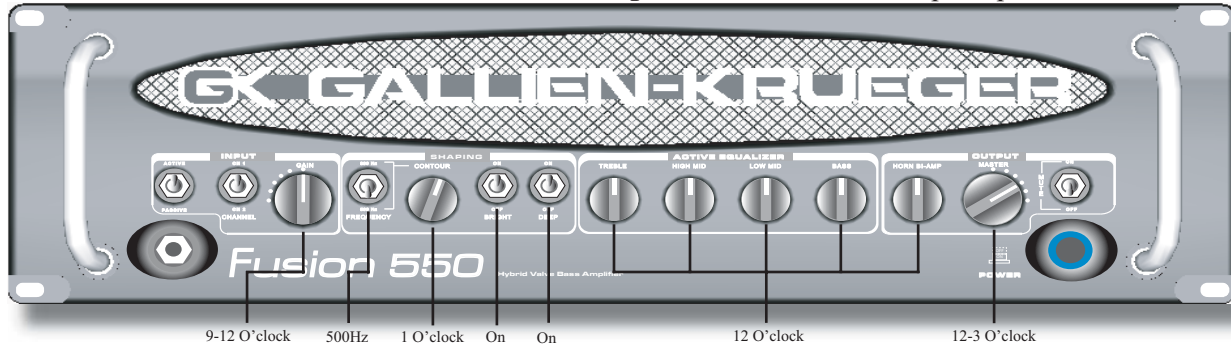

### Rock:

Both pickups recommended.

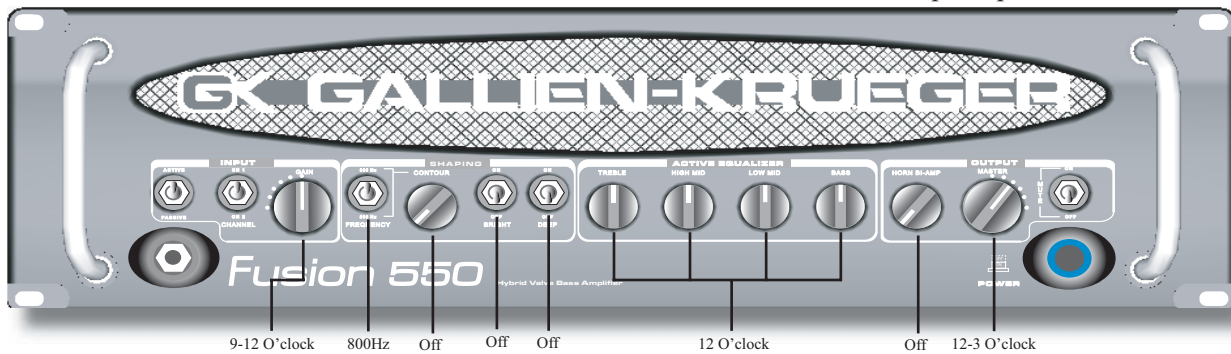

### Reggae:

Neck pickup recommended.

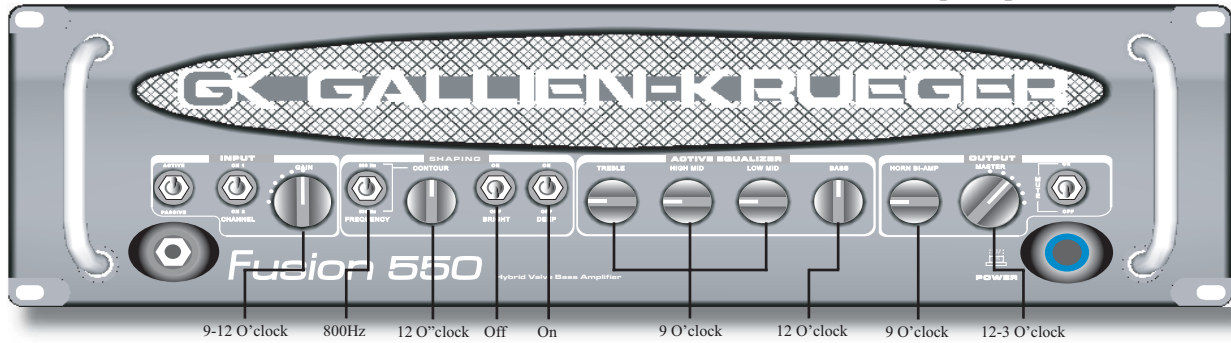

### Jazz/Fusion:

Both pickups recommended.

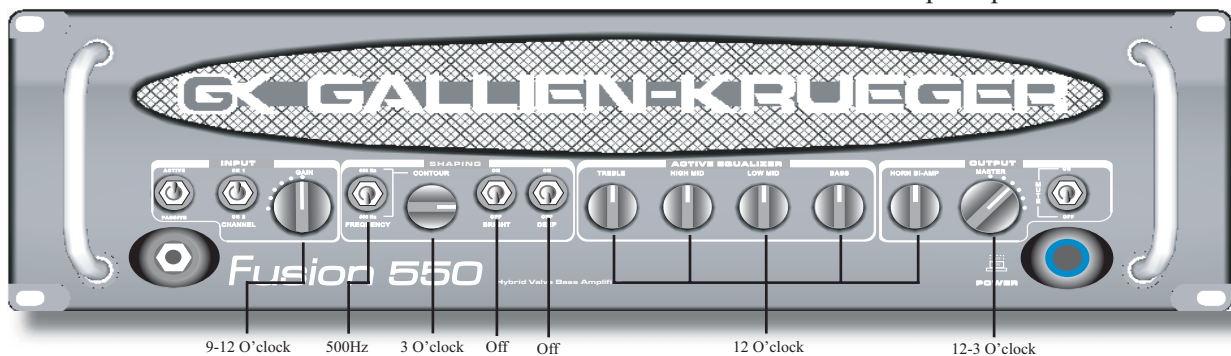

# Fusion 550 Bass Amplifier

## Tech Talk

GK amplifiers are designed to be flexible and user-friendly for maximum performance. This is accomplished through these important features:

**High Current Capability:** When a power amplifier is pushing a speaker cone and it needs to reproduce a high-power transient like a string slap, the amp must be able to deliver a high current pulse to maintain cone control. If the amplifier can't do this it simply cuts the transient off, producing an unresponsive less out front sound. Creating these high current pulses requires extra power devices (four times the current required to deliver its rated power), larger supply capacitors, and intelligent protection logic. GK is the only instrument amplifier manufacturer that goes to the trouble and expense, and it is a big reason why GK amplifiers sound louder and cleaner than other brands at the same power rating.

**Active Equalization:** There are a wide variety of equalizers used in instrument amplifiers today. Passive equalizers are great but only allow you to cut (signal loss), not boost (signal gain). Graphic equalizers provide plenty of variation, but are much better for room equalization. When used with instruments, they tend to sound unnatural or synthetic. The equalizer in GK amplifiers is unique in the industry and reflects over 30 years of continuous development and refinement. We've developed a rotary, four-band, vacuum tube active equalizer optimized for bass guitar. The active circuitry allows you to either boost or cut at a given frequency with greater integrity in signal reproduction. The treble is a shelving type control that boosts the high frequencies evenly. Respectively, the bass is a shelving control that evenly boosts the low frequencies. The high mid and low mid are peak (bandpass) type controls with wide Q (bandwidth) patterns which are much more 'musical' sounding. Each of the four bands are connected in series, meaning the output of the first band is fed directly into the input of the next and so on. This eliminates the rippling or combing effect that can happen with parallel EQ circuits. The overall result from all of this is an equalizer that's flexible, yet easy to use and sounds natural even at extreme settings.

**Shaping:** The three-stage shaping filter simplifies the process of shaping and coloring your tone, enabling the amplifier to accommodate a wide variety of playing styles with minimal fuss.

**Contour:** The Contour is a tube-driven version of the contour circuit from the 800RB. It adds a variable control and center frequency select for precise tone shaping. With the control at zero, the response is essentially 'flat', as in no shaping. As the contour is increased, it scoops out the midrange. Additionally, it compensates to keep the overall volume level constant. With its variable control, the Contour will accommodate everyone from the smooth finger-style player to the aggressive slap player.

**Deep:** The Deep switch extends the low frequency range of the amplifier to accommodate the extra low range of the B string on 5 and 6 string bass guitars. 4 string players may also find desirable results with this filter as well.

**Bright:** The Presence control adds extra sparkle on the high-end for better clarity and 'openness' in your tone. This is particularly useful when soloing or playing chords.

**Horn Bi-Amp Operation:** Bass players have always liked the growl they get from a slightly over driven GK power amp. The problem is that growl sounds great through woofers but will destroy the horn (tweeter). In a typical full range system, there is no way to get that growl while keeping the definition that the horn provides. In GK's Horn Bi-Amp system, an active (electronic) crossover allows a full range signal through to the main (woofer) amplifier, while only the high frequency portion of the signal (5kHz and above) is allowed through to the 50 watt Horn amplifier. There are three primary benefits to this system over a traditional full range system.

- Significantly reduces the risk of blowing out the horn's diaphragm.
- More accurate and natural sounding signal reproduction.
- Allows you to add as much growl to the woofer signal as you want while keeping the horn crystal clear.

**Headroom:** The Fusion 550 amplifier uses a high gain, low noise valve input stage with such a large dynamic range (60v p-p) that even basses with active electronics may not need to use the input pad. The benefit to you is a cleaner signal with less hiss and much less overall noise.

**Efficiency:** The power supply of the Fusion 550 uses a unique design which switches between a low voltage rail for normal output levels and a high voltage rail to accommodate peak levels. This much more efficient approach allows us to build amplifiers with significantly greater output level and significantly less heat and weight. We've also added a temperature sensitive cooling system with a variable speed fan. Under normal conditions, the fan will be off or spinning at a low speed. As the amplifier works harder, the fan speed increases, maintaining a safe temperature level.

**Intelligent Protection Circuitry:** Gallien-Krueger amplifiers use intelligent protection circuitry which constantly monitors for any unsafe operating conditions such as short circuits or

improperly wired speaker cables. If an unsafe condition is detected, the output signal is immediately muted and the power light changes from blue to red. The amplifier will remain muted until the fault is removed. If the protection circuit activates while playing, turn the amplifier off and check that you have not exceeded the maximum recommended impedance load described in this manual.

**Direct Out:** The Fusion 550 uses a transformer balanced DI (Direct Inject) output for connecting to PA and recording consoles. This output is calibrated for 1.0V (0 dBV) and can be adjusted via the Level control to match the input sensitivity of the mixing console. A Ground (Gnd) Lift switch is included to remove hum and buzz when used with equipment connected to a different ground system. The Post EQ button allows you to set the Direct Out signal to either 'Pre' or 'Post' EQ.

**Pre EQ:** With the Pre/Post EQ button out (Pre), the Direct Out signal is fed straight from the input stage and is only effected by the -10dB Pad, Tuning Mute, and the Direct Out Level control. Adjustments to the voicing filters or EQ section will have no effect on the Direct Out signal.

**Post EQ:** With the Pre/Post EQ button in (Post), any changes you make in the Gain, Shaping filters, EQ section and Effects Loop (if used) will affect the Direct Out signal going to the mixing console.

**A Final Word:** You should now have a thorough understanding of how your new GK amplifier works and the advantages it offers in helping to get 'YOUR' sound. If you have any questions or comments, please visit our web site at [www.gallienkrueger.com](http://www.gallienkrueger.com) or send us an e-mail to [info@gallien.com](mailto:info@gallien.com). We wish you the best of times on your musical journey wherever it may lead you.

# Block Diagram

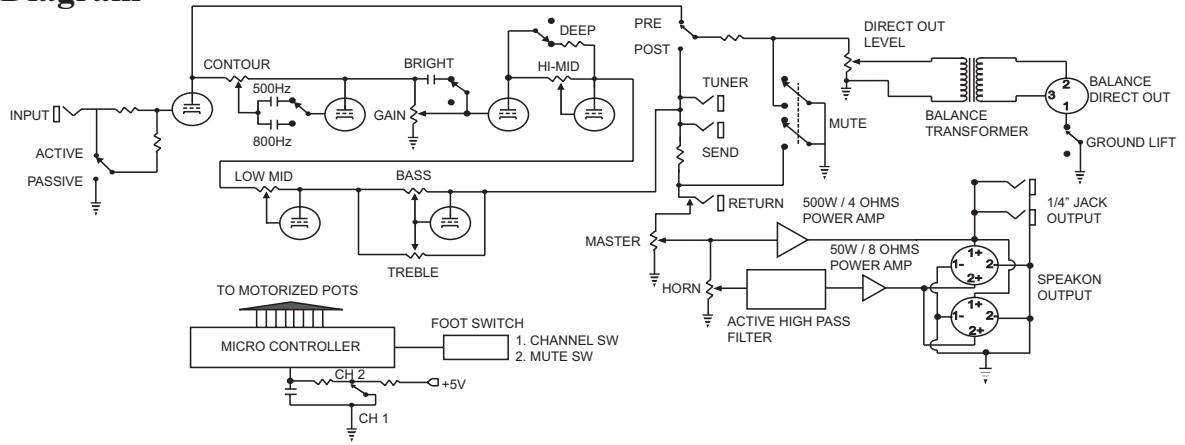

**Output Power:**

Main Amp 350W @ 8 Ohms  
 500W @ 4 Ohms  
 Horn Amp 50W @ 8 Ohms

**Audio Inputs:**

Instrument Input 1/4" Mono, Unbalanced  
 Level 0.6V Rms  
 w/ -14dB pad 1.6V Rms  
 Impedance 1M Ohm  
 Return Input 1/4" Mono, Unbalanced  
 Impedance 50k Ohm

**Audio Outputs:**

Send Output 1/4" Mono, Unbalanced  
 Impedance 220 Ohm  
 Tuner Output 1/4" Mono, Unbalanced  
 Impedance 10k Ohm  
 DI Output XLR, Transformer Balanced  
 Impedance 500 Ohms  
 Speaker Out 1/4" Mono x2  
 Speakon x2

**Equalizer:**

Bass +14dB @ 40Hz  
 Lo-Mid +6dB/-9dB @ 250Hz  
 Hi-Mid +5dB/-8dB @ 1kHz  
 Treble +10/-19dB @ 7kHz

**Voicing Filters:**

Contour -16dB@500Hz or  
 -15dB@800Hz  
 Deep +4dB@30Hz  
 Bright +4dB@10kHz

**Crossover:**

Triple pole constant voltage crossover at 5kHz

**Noise:**

-90dB "A" weighted

**Cooling:**

Variable Speed Fan

**Protection:**

Full short circuit, thermal & RF protection. Stable into reactive and mismatched loads. Five second muted warm-up.

**Dimensions:**

5.25H x 19W x 10D

**Weight:**

27.5lbs.

**Consumption:**

994W(full),  
 230W(average)

**Fuse:**

100V - 120V T 10 A  
 220V - 240V T 5 A

**Mains Voltage:**

USA/Canada 120 Volt/60Hz  
 UK/Australia 240 Volt/50Hz  
 Europe 230 Volt/50Hz  
 Japan 100 Volt/50Hz  
 Korea 220 Volt/50Hz

**Mains Connect:**

Standard IEC Receptacle

