

DMA1

DIGITAL MESSAGE ANNOUNCER INSTALLATION AND OPERATION MANUAL

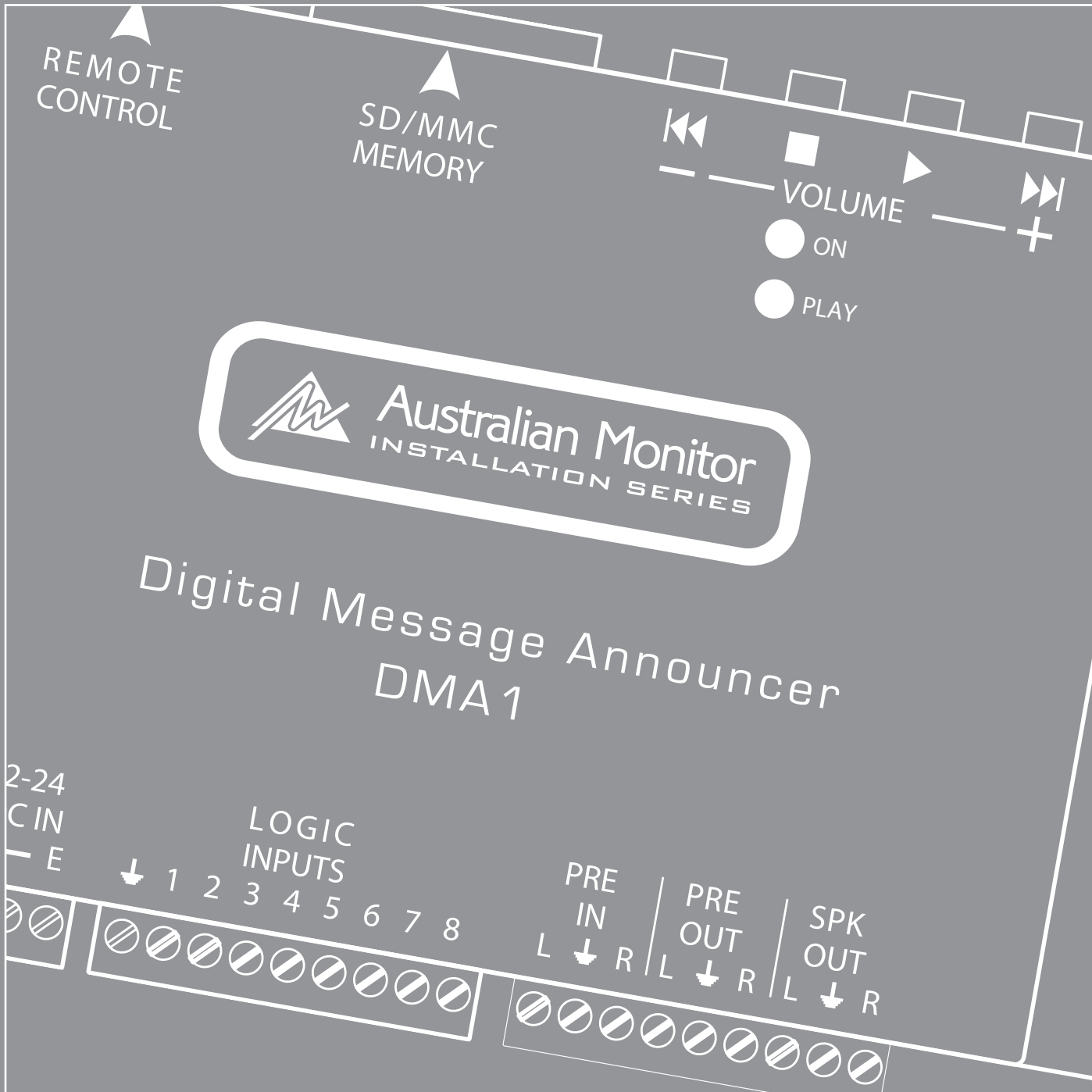



IMPORTANT SAFETY INFORMATION



1. Save the carton and packing material even if the equipment has arrived in good condition. Should you ever need to ship the unit, use only the original factory packing.
2. Read all documentation before operating your equipment. Retain all documentation for future reference.
3. Follow all instructions printed on unit chassis for proper operation.
4. Do not spill water or other liquids into or on the unit, or operate the unit while standing in liquid.
5. Make sure power outlets conform to the power requirements listed on the back of the unit.
6. Do not use the unit if the electrical power cord is frayed or broken. The power supply cords should be routed so that they are not likely to be walked on or pinched by items placed upon or against them, paying particular attention to cords and plugs, convenience receptacles, and the point where they exit from the appliance.
7. Always operate the unit with the AC ground wire connected to the electrical system ground. Precautions should be taken so that the means of grounding of a piece of equipment is not defeated.
8. Mains voltage must be correct and the same as that printed on the rear of the unit. Damage caused by connection to improper AC voltage is not covered by any warranty.
9. Have gain controls on amplifiers turned down during power-up to prevent speaker damage if there are high signal levels at the inputs.
10. Power down & disconnect units from mains voltage before making connections.
11. Never hold a power switch in the "ON" position if it won't stay there itself!
12. Do not use the unit near stoves, heat registers, radiators, or other heat producing devices.
13. Do not block fan intake or exhaust ports. Do not operate equipment on a surface or in an environment which may impede the normal flow of air around the unit, such as a bed, rug, weathersheet, carpet, or completely enclosed rack. If the unit is used in an extremely dusty or smoky environment, the unit should be periodically "blown free" of foreign matter.
14. Do not remove the cover. Removing the cover will expose you to potentially dangerous voltages. There are no user serviceable parts inside.
15. Do not drive the inputs with a signal level greater than that required to drive equipment to full output.
16. Do not connect the inputs / outputs of amplifiers or consoles to any other voltage source, such as a battery, mains source, or power supply, regardless of whether the amplifier or console is turned on or off.
17. Do not run the output of any amplifier channel back into another channel's input. Do not parallel- or series-connect an amplifier output with any other amplifier output. Australian Monitor Inc is not responsible for damage to loudspeakers for any reason.
18. Do not ground any red ("hot") terminal. Never connect a "hot" (red) output to ground or to another "hot" (red) output!
19. Non-use periods. The power cord of equipment should be unplugged from the outlet when left unused for a long period of time.
20. Service Information Equipment should be serviced by qualified service personnel when:
 - A. The power supply cord or the plug has been damaged.
 - B. Objects have fallen, or liquid has been spilled into the equipment
 - C. The equipment has been exposed to rain
 - D. The equipment does not appear to operate normally, or exhibits a marked change in performance
 - E. The equipment has been dropped, or the enclosure damaged.

THIS SAFETY INFORMATION IS OF A GENERAL NATURE AND MAY BE SUPERSEDED BY INSTRUCTIONS CONTAINED WITHIN THIS MANUAL

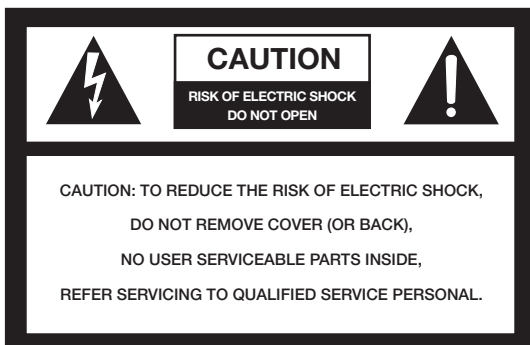

WARNING!

**TO REDUCE THE RISK OF FIRE OR ELECTRIC SHOCK
DO NOT EXPOSE THIS EQUIPMENT TO RAIN OR MOISTURE.**



This symbol is intended to alert the user to the presence of uninsulated "dangerous voltage" within the products enclosure that may be of sufficient magnitude to constitute a risk of electric shock to persons.



This symbol is intended to alert the user to the presence of important operational and maintenance (servicing) instructions in the literature accompanying the appliance.

Caution:

To prevent electric shock do not use this (polarised) plug with an extension cord, receptacle or other outlet unless the blades can be fully inserted to prevent blade exposure. To prevent electric shock, match wide blade of plug to wide slot, fully insert.

INTRODUCTION AND CONTENTS

1. INTRODUCTION	4	6. PLAYLIST OPERATION	17
1.1 Introduction		6.1 Introduction to playlist mode operation	
1.2 What is MP3?		6.2 What is a playlist file?	
1.3 Encoder		6.3 Playlist activation by logic inputs - MPLL (Mode PlayList) parameter	
1.4 Decoder		6.4 Stop & Play Priority Playlist	
1.5 Player		6.5 Priority Playlist	
1.6 Wave		6.6 Stop & Play Standard Playlist	
1.7 Audio compression in various formats		6.7 Standard Playlist	
2. INSTALLATION	5	6.8 Stop & Play Restart Playlist	
2.1 Contents of the DMA1 kit		6.9 Restart Playlist	
2.2 Notices		7. OPERATION WITH LOGIC INPUTS	20
3. DESCRIPTION AND CONNECTIONS	6	7.1 Logic input operating mode	
3.1 Command description		7.2 Binary input command codes	
3.2 Connection description		8. SPECIAL FUNCTIONS	26
3.3 Power supply		8.1 Connection of two DMA1s	
3.4 Logic inputs		8.2 Amplifier bridging (40W)	
3.5 IN/OUT 8 - Vlink input/output		9. RS485 SERIAL COMMUNICATION	28
3.6 Serial RS485 connection		9.1 RS485 communication	
3.7 Line level audio input		9.2 Serial port communication parameters (config.txt)	
3.8 Line level audio output		9.3 Framing error	
3.9 Amplified audio output		9.4 NAK reply by a DMA1	
4. CONFIGURATION FILE	9	9.5 Transmitting a command from a control system	
4.1 What is the configuration file?		9.6 Basic format of dedicated protocols	
4.2 Content of the configuration file		9.7 Basic set-up of data packets	
4.3 How it is managed by the DMA1		9.8 Control codes	
4.4 Preparing the file		9.9 Address (ADD)	
4.5 Storing files in Flash memory		9.10 Command (CMD)	
4.6 Audio adjustment parameters		9.11 CheckSum (CHK)	
4.7 Timing and switchover parameters		9.12 Basic protocol	
4.8 Diagram of operating parameters		9.13 Basic protocol with CheckSum	
4.9 Input management parameters		9.14 Basic protocol with CR and LF	
4.10 Infrared movement sensor management parameters		9.15 Basic protocol with CheckSum, CR and LF	
5. SCHEDULED OPERATION	15	9.16 List of commands	
5.1 Introduction to timed operation		9.17 Error codes	
5.2 The palimpsest file – palin.txt		10. SPECIFICATIONS	40
5.3 Mixer function		10.1 Technical features	
5.4 AVC function – automatic control of the output volume		10.2 Maintenance and conservation	
		10.3 Disposal	

INTRODUCTION

1.1 Introduction

The Australian Monitor Installation Series DMA-1 digital message announcer is a compact yet highly featured digital playback device. Utilizing an SD card digital storage format the DMA1 delivers high quality stereo audio in an MP3 format. Messages can be played or triggered using the on-board controls, via remote switches, contact closure or via RS485 serial control. The DMA-1 also boasts an on board 20 watt per channel D class power amplifier as well as stereo inputs & outputs which allow it to be inserted in line with another BGM feed.

The DMA-1's compact size belies the wealth of features it offers. It is a highly innovative & cost effective digital message storage & playback device that has a host of commercial applications.

1.2 What is MP3?

MP3 is an acronym for Mpeg-1 layer 3. This is an audio compression standard which eliminates sounds which the human ear cannot hear via a psycho-acoustic algorithm. The purpose of this compression is to reduce the space taken up by an audio file while still ensuring excellent quality. The greater the compression, the less the audio quality. The right compromise, which guarantees a quality comparable to that of a Compact Disc, is 128 Kbps (thousands of bits per second) which represents the most widely used manner, and reduces the size of an uncompressed file by 10 times.

1.3 Encoder

Software which compresses a CD audio or wave file in MP3. There are many programmes of this kind, and it is virtually impossible to say which is the best. Freeware software encoders suitable for various operating systems can be downloaded from the following internet site: www.mp3server.4t.com

1.4 Decoder

Software which decompresses an MP3 audio file in order to send it to a digital-analog converter and reconstruct the original audio signal.

1.5 Player

Hardware and software system able to read MP3 audio files. The DMA1 is able to carry out this function.

1.6 Wave

High quality audio format (extension .wav), compatible with the tracks of normal music CD's. CD quality music utilises a sample rate of 44.1 KHz/sec. at 16 bit in stereo, but the size of the file is approximately about 10Mb per minute.

1.7 Audio compression in various formats

The following graphic shows the space taken up by an uncompressed audio file of about 5 minutes (.wav) and compressed in MP3 at 128Kbps (MP3).



INSTALLATION

2.1 Contents of the DMA1 kit

1x DMA1 device

1x DMA1 user manual

1x 240VAC mains power adaptor

1x 128MB flash memory

2.2 Notices

1. The DMA1 has been designed to work only with the following mains power supply adaptors: 12-15VAC, 12-24VDC.
2. The device must be serviced only by qualified staff.
3. In order to prevent the risk of fire or shock do not put objects inside the device through openings
4. Disconnect the device from power before cleaning. Clean the device using a soft, dry cloth. Do not use liquids or sprays which contain flammable substances.

DESCRIPTION AND CONNECTIONS

3.1 Command description

- 1 Connector for external connection of memory and command buttons
- 2 Flash memory slot for Secure Digital or MultiMedia Card
- 3 Command keys:

⏪ = (brief pressure) previous MP3 file / (prolonged pressure) reduce output volume

■ = STOP

▶ = PLAY

⏩ = (brief pressure) next MP3 file / (prolonged pressure) increase output volume

- 4 Red LED: lit = device is on
- 5 Green LED: lit = MP3 file playing;
blinking = DMA1 in pause/STOP.

⚠ IMPORTANT!

- Volume control via the keys is only possible during the playing of an MP3 audio file
- Pressing STOP during playing causes the DMA1 to pause, until reactivation with the PLAY key. This condition is indicated by the blinking green LED

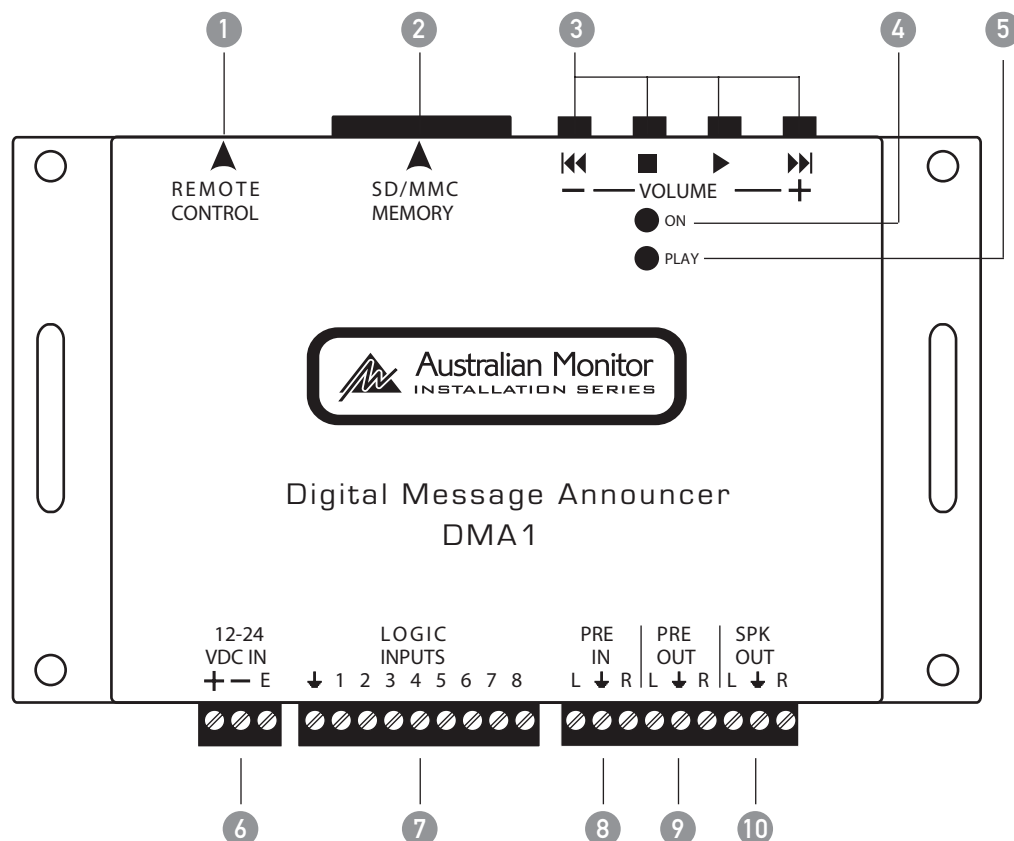

DESCRIPTION AND CONNECTIONS

3.2 Connection description

6 VAC/DC	Power input 12-15VAC or 12-24VDC	8 IN L	Line level audio input (left channel), for connection of external music sources (SAT, CD, Tuner etc) to be mixed with DMA1 generated audio
6 +12VDC	Auxiliary + 12Vdc voltage, available for input activation or external feed sensors. MAX. 100mA	8 GND	Ground signal of line level audio input
7 GND	Ground for input activation using external contacts; auxiliary ground voltage	8 IN R	Line level audio input (right channel), for connection of external music sources (SAT, CD, Tuner etc) to be mixed with DMA1 generated audio
7 IN1	Multi-function input for activating 1.mp3 file or 1.m3u playlist (direct or bit 0 in binary combination)	9 OUT L	Line level audio output (left channel)
7 IN2	Multi-function input for activating 2.mp3 file or .m3u playlist (direct or bit 1 in binary combination)	9 GND	Ground signal of line level audio output
7 IN3	Multi-function input for activating 4.mp3 file or 3.m3u playlist (direct or bit 2 in binary combination)	9 OUT R	Line level audio output (right channel)
7 IN4	Multi-function input for activating 8.mp3 file or 4.m3u playlist (direct or bit 3 in binary combination)	10 SPK L	Amplified audio output for speaker (20W), left channel
7 IN5/485A	Multi-function input for activating 16.mp3 file or 5.m3u playlist (direct or bit 4 in binary combination) configurable for serial RS485 communication (see chap. 9)	10 GND	Ground signal of amplified audio output
7 IN6/485B	Multi-function input for activating 32.mp3 file or 6.m3u playlist (direct or bit 5 in binary combination). Configurable for serial RS485 communication (see chap. 9)	10 SPK R	Amplified audio output for speaker (20W), right channel
7 IN/OUT7	Multi-function input/output for activating 64.mp3 file or 7.m3u playlist (direct or bit 6 in binary combination)		
7 IN/OUT8	Multi-function input/output for activating 128.mp3 file (direct or bit 7 in binary combination) Configurable for external applications. 0=in standby, 1=in play (+12V). Permits two DMA1s to be connected in cascade for the synchronised management of music playlists and commercials spots (spot announcements) in a scheduled time frame (connection Vlink, par. 8.1)		

DESCRIPTION AND CONNECTIONS

3.3 Power supply

The DMA1 may operate with the following main power adaptors: 12-15VAC, 12-24VDC.

It is recommended to use the mains adaptor supplied with the device. The red POWER LED lights up when power is present.

3.4 Logic inputs

The DMA1 has eight multi-function logic inputs to control the playing of the either playlists or individual audio files.

The pins are:

- 1- GND
- 2- IN 1
- 3- IN
- 4- IN 3
- 5- IN 4
- 6- IN 5
- 7- IN 6
- 8- IN 7
- 9- IN 8

In order to activate the playing of a file, connect the desired logic input pin to GND (or the desired logic input pins when operating in binary logic).

3.5 IN/OUT 8 - input/output Vlink

Programmable logic input/output to connect two DMA1s in cascade, for synchronised management of music playlists with commercials/spots at scheduled intervals without interruptions.

Vlink: 0 = in standby
1 = in play (+12V)

3.6 Serial RS485 connection

The DMA1 can be connected to an RS485 bus that can be controlled by a Crestron control system, or any other RS485 enabled control system. To enable RS485 control, (pin IN5/485A and IN6/485B), remove the cover of the DMA1 and move the relative jumpers (see para. 9.1).

3.7 Line level audio input

Line level audio input (stereo) allowing the connection of an external music source (SAT, CD, Tuner, second DMA1 etc) that is mixed with DMA1 generated audio. This functionality allows the mixing of a music source with scheduled commercials or spot announcements.

3.8 Line level audio output

Line level audio output (stereo) on extractable terminal strip.

3.9 Amplified audio output

Amplified stereo audio output (20W + 20W) for the connection of external speakers.

Connect external 4/8Ω speakers to the SPK L/GND and SPK R/GND terminal strip.

It is recommended to cable the DMA1 far from power cables. The two cables that connect the speaker with the DMA1 amplified audio output terminals can be a potential source of interference.

CONFIGURATION FILE

4.1 What is the configuration file?

The DMA1 is a very versatile device which can be adapted to the needs of the application in which it is used. Different applications may require adjustment of volume, tone, loudness, communication parameters and timing. The configuration file stored in the main directory of the flash memory, together with the audio files, makes it possible to programme the various parameters of the DMA1.

This file must be assigned the name config.txt (this extension has been used so it can be modified by any text editor, including PocketPC text editors).

4.2 Content of the configuration file

Each line of the configuration file consists of:

- Mnemonic code of the parameter to be set. It always consists of our CAPITAL alphanumeric characters, and must always be at the beginning of the line. No more than one parameter is permitted on the same line
- Separating '=' character. This MUST be inserted just after the mnemonic code, without any spacing or tab characters
- The relevant numerical parameter expressed as a decimal, to be inserted directly after the separation character, without any spacing or tab characters

Example: LMP3=14
LOUT=14
LLIN=14
LLI2=5
LLOU=10
LTRE=10
LBAS=10
MOMD=0

4.3 How it is managed by the DMA1

At the time the DMA1 is turned on, or when the flash memory card is inserted, the DMA1 will start to read the main directory of the flash memory. If the file config.txt is found, the DMA1 will store the configuration parameters into its own internal non-volatile memory. The parameters therefore stay in the internal memory of the DMA1 even after the device has been turned off or the flash memory card removed. It is therefore not mandatory for the configuration file to always be present on the flash memory card. Once all the parameters have been read and stored to the DMA1, the config.txt file can be deleted.

 NOTE: If it is necessary to configure multiple DMA1s with the same configuration parameters, a single flash memory card with the appropriate config.txt file can be prepared and sequentially insert this memory card into all the DMA1s to be configured. The final flash memory cards to be inserted into each DMA1 now only need to contain the MP3 audio files.

4.4 Preparing the file

Any ordinary text editor (like Windows Notebook) can be used to create the config.txt file. The file must be saved as a pure text file (.txt). Should other programmes be used (e.g. Microsoft Word) be careful to save the document as "text only": otherwise control characters would be inserted which would make it impossible for the DMA1 to interpret the file.

4.5 Storing files in flash memory

The configuration file and all the MP3 audio files can be stored to the flash memory card via a special USB reader/writer for PC.

CONFIGURATION FILE

4.6 Audio adjustment parameters

The DMA1 allows for the following audio adjustments:

- Independent adjustments of the MP3 file level, line level audio input volume and general amplified/line level output volume
- Adjustment of loudness level
- Separate adjustment of bass and treble tone control

- Adjusting the level of the background music while delivering commercials/spot announcements
- Activation/deactivation of power amplifier muting mode

The following tables show the relation between the value set in the configuration file and the actual value of the audio parameter.

MNEMONIC	DESCRIPTION
LMP3	MP3 decoder output level (value between 0 and 20 in decimal)
LOUT	Main audio output volume (line level outputs and amplified audio outputs) (value between 0 and 20 in decimal)
LLIN	Line level input volume when no MP3 are playing (value between 0 and 20 in decimal)
LLI2	Line level input volume during the playback of MP3 files (value between 0 and 20 in decimal)
LLOU	Loudness level (value between 0 and 20 in decimal)
LTRE	Treble tone control (value between 0 and 20 in decimal)
LBAS	Bass tone control (value between 0 and 20 in decimal)
MOMD	Power amplifier muting mode (0=OFF/1=ON).

LMP3 (MP3 DECODER OUTPUT LEVEL)

VALUE	0	1	2	3	4	5	6	7	8	9	10	11	12	13	14	15	16	17	18	19	20
LEVEL	OFF	2%	5%	9%	14%	20%	26%	33%	40%	48%	56%	66%	77%	88%	100% 0dB	112%	128%	144%	161%	178%	200% +6dB

LOUT (MAIN AUDIO OUTPUT VOLUME FOR LINE LEVEL AND AMPLIFIED AUDIO OUTPUTS)

VALUE	0	1	2	3	4	5	6	7	8	9	10	11	12	13	14	15	16	17	18	19	20
LEVEL	OFF	-55 dB	-35 dB	-28 dB	-23 dB	-20 dB	-17 dB	-14 dB	-12 dB	-10 dB	-8 dB	-6 dB	-4 dB	-2 dB	0 dB	+2 dB	+4 dB	+6 dB	+8 dB	+10 dB	+12 dB

LLIN (INL/INR VOLUME WHEN NO MP3 IS PLAYING)

VALUE	0	1	2	3	4	5	6	7	8	9	10	11	12	13	14	15	16	17	18	19	20
LEVEL	OFF	-55 dB	-35 dB	-28 dB	-23 dB	-20 dB	-17 dB	-14 dB	-12 dB	-10 dB	-8 dB	-6 dB	-4 dB	-2 dB	0 dB	+2 dB	+4 dB	+6 dB	+8 dB	+10 dB	+12 dB

LLI2 (INL/INR VOLUME DURING THE PLAYBACK OF MP3 FILES (BACKGROUND MUSIC))

VALUE	0	1	2	3	4	5	6	7	8	9	10	11	12	13	14	15	16	17	18	19	20
LEVEL	OFF	-55 dB	-35 dB	-28 dB	-23 dB	-20 dB	-17 dB	-14 dB	-12 dB	-10 dB	-8 dB	-6 dB	-4 dB	-2 dB	0 dB	+2 dB	+4 dB	+6 dB	+8 dB	+10 dB	+12 dB

LLOU (LOUDNESS LEVEL)

VALUE	0	1	2	3	4	5	6	7	8	9	10	11	12	13	14	15	16	17	18	19	20
LEVEL	0 dB	+0,5 dB	+1 dB	+1,5 dB	+2 dB	+2,5 dB	+3 dB	+4 dB	+5 dB	+6 dB	+7 dB	+8 dB	+9 dB	+10 dB	+11 dB	+12 dB	+13 dB	+14 dB	+15 dB	+16 dB	+17 dB

LTRE (TREBLE TONE CONTROL)

VALUE	0	1	2	3	4	5	6	7	8	9	10	11	12	13	14	15	16	17	18	19	20
LEVEL	-12 dB	-10 dB	-8 dB	-7 dB	-6 dB	-5 dB	-4 dB	-3 dB	-2 dB	-1 dB	0 dB	+1 dB	+2 dB	+3 dB	+4 dB	+5 dB	+6 dB	+7 dB	+8 dB	+10 dB	+12 dB

CONFIGURATION FILE

LBAS (BASS TONE CONTROL)

VALUE	0	1	2	3	4	5	6	7	8	9	10	11	12	13	14	15	16	17	18	19	20
LEVEL	-12	-10	-8	-7	-6	-5	-4	-3	-2	-1	0	+1	+2	+3	+4	+5	+6	+7	+8	+10	+12
	dB	dB	dB	dB	dB	dB	dB	dB	dB	dB	dB	dB	dB	dB	dB	dB	dB	dB	dB	dB	dB

MOMD (MODE OUTPUT MUTING DISABLE)

MOMD 1 = Muting Deactivated (Internal Power Amplifier Always Active)
 0 = Muting Active (Internal Power Amplifier Is Only Active During The Playing Of The Mp3 Files)

4.7 Timing and switchover parameters

The fade times, reaction time of the automatic output volume control and the delay time for starting the commercial/spot announcement at the end of the piece of music, can be modified with the following configuration parameters.

Example: TFOU=15
 TFIN=15
 TAVC=3
 TADU=15

MNEMONIC	DESCRIPTION OF TIMING PARAMETER
TFOU	Setting the Fade-Out time in 1/10 of one second (value between 1 and 30 in decimal)
TFIN	Setting the Fade-In time in 1/10 of one second (value between 1 and 30 in decimal)
TAVC	Setting the reaction time of the automatic output volume control
TADU	Setting the delay time of the commercial/spot in 1/10 of one second (when two DMA1s are operating in cascade) (value between 0 and 20 in decimal)

TFOU (FADE OUT TIME): SETTING THE FADE OUT TIME OF THE INL/INR AUDIO INPUT BEFORE PLAYING THE MP3 FILE

VALUE	1	2...4	5	6...9	10	11...14	15	16...19	20	21...24	25	26...29	30
TIME	1/10 second		½ second		1 second		1,5 seconds		2 seconds		2,5 second		3 second

TFIN (FADE IN TIME): SETTING THE FADE IN TIME OF THE INR/INL AUDIO INPUT AFTER PLAYING THE MP3 FILE

VALUE	1	2...4	5	6...9	10	11...14	15	16...19	20	21...24	25	26...29	30
TIME	1/10 second		½ second		1 second		1,5 seconds		2 seconds		2,5 seconds		3 seconds

TAVC: SETTING THE REACTION TIME OF THE AUTOMATIC OUTPUT VOLUME CONTROL

VALUE	0	1	2	3	4
TIME	OFF	2/10 seconds	2 seconds	4 seconds	8 seconds

TADU: SETTING THE DELAY TIME OF THE PLAYING A COMMERCIAL/SPOT IN 1/10 SECOND (TWO DMA1S IN CASCADE)

VALUE	1	2...4	5	6...9	10	11...14	15	16...19	20	21...24	25	26...29	30
TIME	1/10 second		½ second		1 second		1,5 seconds		2 seconds		2,5 seconds		3 seconds

CONFIGURATION FILE

4.8 Diagram of operating parameters

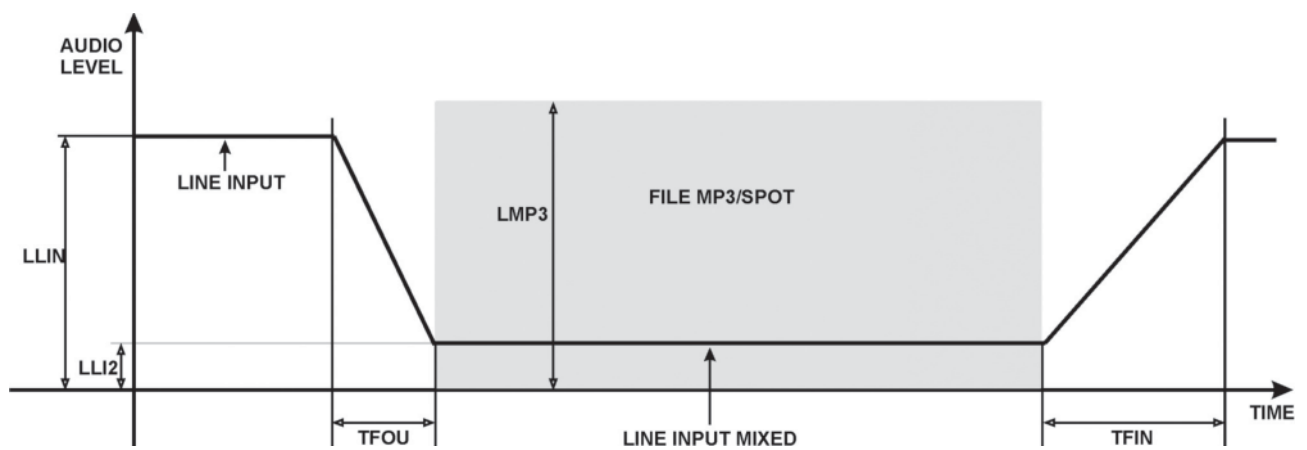
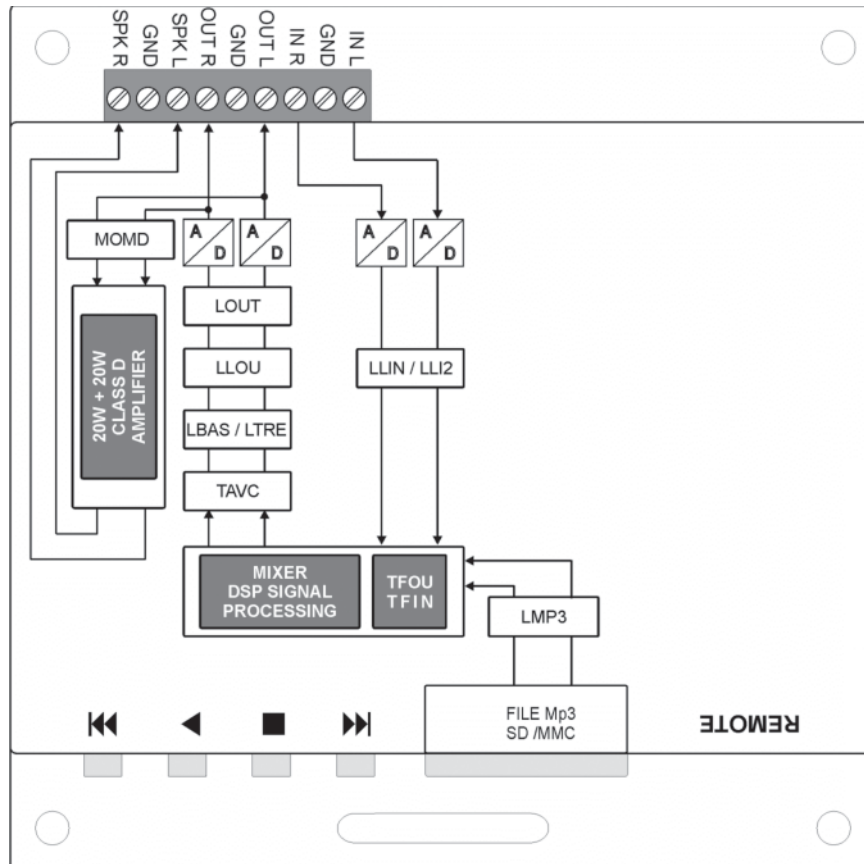

CONFIGURATION FILE

4.9 Input management parameters

The playing of MP3 files takes place by activating the logic inputs. The activation modes are set through the IMOD, TPCM MICP and MIRS parameters inserted in the configuration file.

Example: IMOD=0
TPCM=10
MICP=1
MIRS=0

MNEMONIC	DESCRIPTION OF TIMING PARAMETER
IMOD	Setting the mode of the logic inputs as either active high or active low
TPCM	Setting the persistence time of the input command (time to wait before the DMA1 interprets the input command) expressed in decimals of milliseconds (value between 0 and 255 in decimal).
MICP	Setting Mode Input Continuous Play
MIRS	Setting Mode Input ReStart

IMOD (INPUT MANAGEMENT MODE)

IMOD	0 = active-low input mode; the logic input is active when connected to the ground/GND of the device
	1 = active-high input mode; the logic input is active when connected to a positive voltage between 5 and 12VDC

TPCM (TIME PERSISTENCE INPUT COMMAND MODE)

TPCM	0 = no delay	100= 1 second
	1 = 10mSeconds	200= 2 seconds
	2 = 20mSeconds	250= 2.5 seconds

MICP (MODE INPUT CONTINUOUS PLAY)

MICP	0 = having terminated the playing of the MP3 file, the DMA1 goes into standby
	1 = the requested MP3 file is continuously played until a new input code is entered

MIRS (MODE INPUT RESTART)

MIRS	0=repeated activation or deactivating of the same input code does not influence the playing of the relevant MP3 file. Only the activation of a different code can stop the playing of the current MP3 file and activate the playing of a new MP3 file
	1=The relevant MP3 file commences playing from the beginning, even if the same MP3 is already in play

CONFIGURATION FILE

4.10 Infrared movement sensor management parameters

IMPORTANT: the following parameters are enabled exclusively for the IN1 input.

Example: PYDT=1
 PYDL=10
 TAPL=0
 RSPL=3

MNEMONIC	DESCRIPTION
PYDT	Activation of IR sensor on IN1 logic input (0=OFF/1=ON)
PYDL	Delay time between the completion of playing an MP3 file and the next IR sensor activation (value between 0 and 240 in decimal)
TAPL	Setting of the AUTOPLAY time for playing of a message when the IR sensor is not activated (value between 0 and 240 in decimal)
RSPL	Delay time between IR sensor movement detection and commencement of MP3 playback (value between 0 and 20 in decimal)

PYDT (ACTIVATION INFRARED MOVEMENT SENSOR)

PYDT	1 = IR sensor activated
	0 = IR sensor deactivated

PYDL (DELAY TIME BETWEEN END OF MP3 PLAYBACK AND IR SENSOR RE-ACTIVATION)

VALUE	0	1	2	3	4	5	10	20	30	60	120	180	240
TIME	IR	1 second	2 seconds	3 seconds	4 seconds	5 seconds	10 seconds	20 seconds	30 seconds	1 minute	2 minutes	3 minutes	4 minutes

TAPL (SETTING AUTOPLAY TIME FOR PLAYING FILES WHEN THE IR SENSOR IS NOT ACTIVATED)

VALUE	0	1	2	3	4	5	6	12	18	30	60	180	240
TIME	NOT managed	10 seconds	20 seconds	30 seconds	40 seconds	50 seconds	1 second	2 seconds	3 seconds	5 minutes	10 minutes	30 minutes	40 minutes

RSPL (DELAY TIME BETWEEN IR MOVEMENT DETECTION AND START OF MP3 PLAYBACK)

VALUE	1	2...4	5	6...9	10	11...14	15	16...19	20	21...24	25	26...49	50
TIME	1/10 second		1/2 second		1 second		1,5 seconds		2 seconds		2,5 seconds		5 seconds

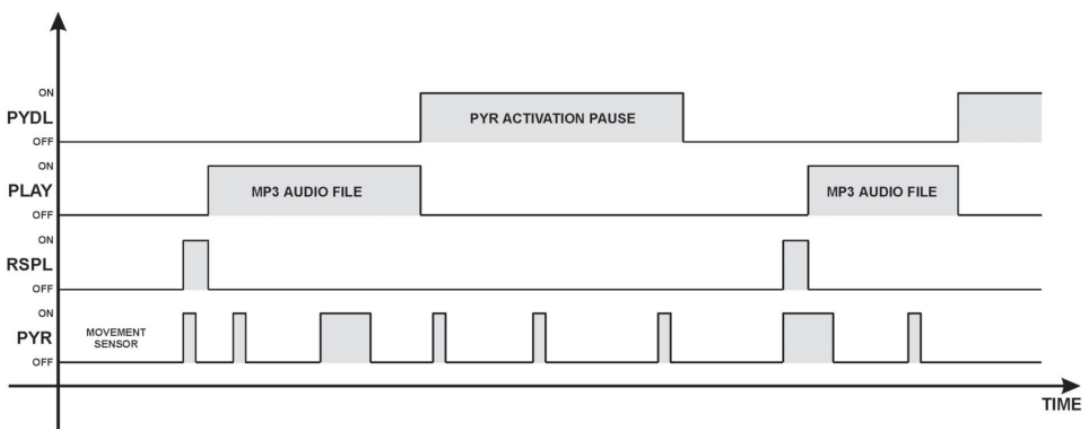

SCHEDULED OPERATION

5.1 Introduction to timed operation

When the flash memory card is inserted, the DMA1 will analyse its “ contents and – depending on the files which are present – will automatically set the mode of operation.

In the presence of the PALIN.TXT file, the DMA1 plays the sequence of MP3 files in a cyclical emission (one hour cycles) called PALIMPSEST which are contained in the same PALIN.TXT file.

5.2 The palimpsest file – palin.txt

The DMA1 can manage a list of MP3s to be played according to pre-set time intervals. This list is a simple text file (palin.txt) which contains a number of time events along with a sequence of MP3 files to be played for each specific time event.

There are a few simple rules on how to set the palimpsest; firstly the time for an event must be defined in minutes. Eg: 00:10

 NOTE: It is very important to start a new line of text for each event, and to separate the hours from the minutes using the (:) character.

On the same line the names of the MP3 audio files to be used (and their sequence) must be defined (max. 8 characters).

There are three different acceptable formats for separating multiple MP3 filenames for each event

1. Separating character [Tab] between one MP3 and the next:
E.g.: 00:10 spot01 spot02 spot03
2. Comma (,) between one MP3 and the next:
E.g.: 00:10,spot01,spot02,spot03
3. Semicolon (;) between one MP3 and the next:
E.g.: 00:10;spot01;spot02;spot03

Once the configuration has been completed, the file will appear similar to the following example:

00:00	SPOT04	SPOT07			
00:05	SPOT09	SPOT17			
00:10	SPOT11	SPOT02			
00:15	SPOT01	SPOT08	SPOT03	SPOT06	SPOT05
00:20	SPOT12	SPOT03			
00:25	SPOT16	SPOT17			
00:30	SPOT09	SPOT10			
00:35	SPOT05	SPOT11	SPOT12	SPOT13	SPOT14
00:40	SPOT02	SPOT11			
00:45	SPOT04	SPOT07			
00:50	SPOT02	SPOT11			
00:55	SPOT09	SPOT11			

EXAMPLE OF PALIN.TXT FILE WITH CYCLICAL EMISSION AT INTERVALS OF 5 MINUTES OF COMMERCIAL SPOTS

An example of the reading and functioning of a timetable is provided below:

00:05	SPOT05	SPOT11	SPOT12
00:11	SPOT01	SPOT07	SPOT03

In this case the DMA1 remains in standby for 5 minutes from the moment it is turned on. At the 5th minute the DMA1 fades out the external line level audio input source in order to play the 00:05 time event, composed of 5 MP3 files.

Once the time event has finished playing Spot05, Spot11, Spot12, Spot13 and Spot14, the DMA1 fades the external line level audio input back in. Upon reaching the 11th minute the DMA1 fades out the external line level audio input source and plays the 00:10 time event, composed of 3 MP3 files.

SCHEDULED OPERATION

⚠ IMPORTANT! When using the line level audio inputs, check the settings of the LLIN, LLI2 and MOMD parameters inserted in the configuration file (par. 4.6).

Programming limits:

Max. programming time permitted	1 hour (cyclic)	From 00:00 to 00:59
Max. quantity of time events	60 events	
Max. quantity of MP3s per time event	8 MP3 files	
Max. quantity of MP3s per palimpsest	500 MP3 files	

5.3 Mixer function

The DMA1 has an audio input for connection to external music sources, with a mixer function to mix this source with the files played from flash memory (see par. 8.3). At the time scheduled for delivering each time event the DMA1 fades out the external audio source from the level LLIN to the

level LLI2, according to a programmed fade time TFOU. Then the sequence of MP3 files of the time event are played at LMP3 level, mixed with the external audio with level LLI2.

Once the time event has finished, the DMA1 brings the external audio source back to the level LLIN according to a programmed fade time TFIN.

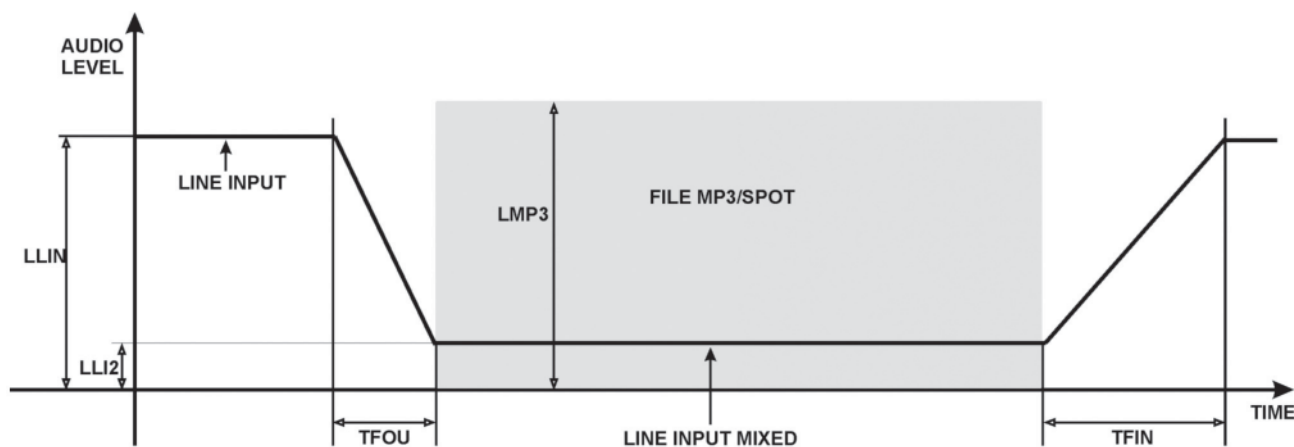

PLAYLIST OPERATION

6.1 Introduction to playlist mode operation

When the flash memory is inserted, the DMA1 analyses its content to define its mode of operation based upon the files present:

1. File: PLAYLIST.TXT plays audio files in sequence according to the list present in the file
2. File: 1.M3U, 2.M3U, 3.M3U, 4.M3U, 5.M3U, 6.M3U, 7.M3U plays audio files in sequence according to the list present, activated by logic input

IN1 = 1.m3u IN2 = 2.m3u IN3 = 3.m3u IN4 = 4.m3u
IN5 = 5.m3u IN6 = 6.m3u IN7 = 7.m3u

During play the four command buttons REW, STOP, PLAY and FWD are active.

6.2 What is a playlist file?

The DMA1 is able to follow a sequence or list of audio files; this play list is a simple text file called playlist.txt which can be inserted in the main directory of the same memory containing the audio files.

Follow a few, easy rules to set the sequence:

Example	1	Example	intro
with	3	with	part 1
numbers:	7	names:	part 2
	9		monologu
	5		music
	01		part 3
	005		finale

IMPORTANT!

- Rename the MP3 audio files with numbers or names with 8 characters max.
- Do not write in the extension (.mp3)
- Max. 500 MP3 files per playlist

Insert the flash memory card and wait for the DMA1 to read the playlist. At the end of the reading operation, if the names of the pieces have been fitted in correctly, the DMA1 will automatically start to play the MP3 files in the programmed sequence or wait the activation of a logic input.

6.3 Playlist activation by logic inputs - MPLL (Mode PLayerList) parameter

The seven available playlists activated by the logic inputs, can be played with different modes depending upon the varying needs.

To choose between the different modes of operation the configuration parameter MPLL (Mode PLayerList) must be defined in the config.txt file.

When the flash memory card is inserted, the DMA1, depending on the setting of the parameter MPLL in the file config.txt, will switch over to the relevant mode of operation.

IMPORTANT!

- The names of the 7 playlists are fixed
- The loading times of the Playlists may last even tens of seconds, during which the DMA1 is not able to play

CONFIGURATION FILE

6.4 MPLL=10: Stop & Play Priority playlist

Operating mode:

- Upon activation of a logic input, the first MP3 in the playlist is played. At the end of the MP3 file the DMA1 goes in standby, awaiting further logic input activation. Activating the logic input once again, or if the logic input remains active, the next MP3 file in the playlist is played
- Repeated activations or deactivations of the same logic input or of other inputs does not interrupt the playing of an MP3 file
- The playlist is looped, as long as the relative logic input remains activated

INPUT		RELATIVE PLAYLIST	
NONE	=	STANDBY	
IN 1	=	1.M3U	
IN 2	=	2.M3U	
IN 3	=	3.M3U	
IN 4	=	4.M3U	
IN 5	=	5.M3U	
IN 6	=	6.M3U	
IN 7	=	7.M3U	
IN 8	=	V LINK FUNCTION	

NOTE: If several inputs are activated, the lowest playlist is activated. For example, if IN4 and IN5 are active, the playlist 4.m3u is played.

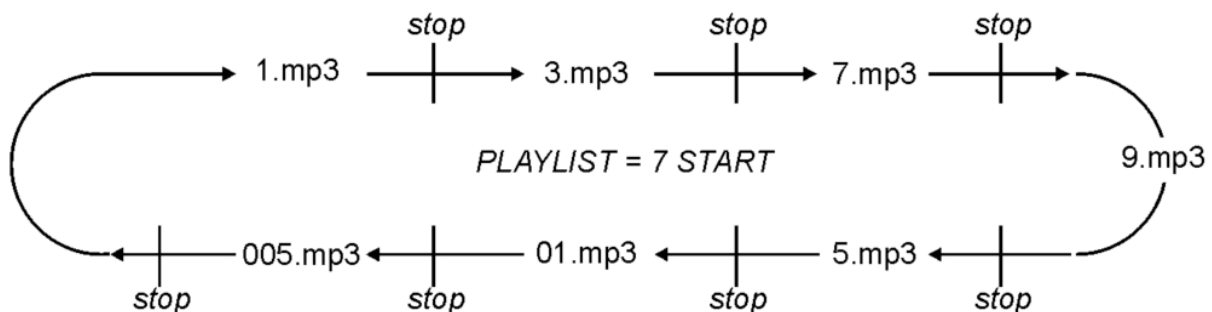

PLAYLIST OPERATION

6.5 MPLL=11: Priority playlist

Operating mode:

- Upon activation of a logic input, the MP3 files in the playlist are played in sequence. At the end of the playlist the DMA1 goes in standby, awaiting further logic input activation. Activating the logic input once again, or if the logic input remains active, the MP3 files in the playlist are played again
- Repeated activations or deactivations of the same logic input or of other inputs does not interrupt the playing of an MP3 file
- The playlist is looped, as long as the relative logic input remains activated



6.6 MPLL=12: Stop & Play Standard playlist

Operating mode as MPLL=10 except:

- Repeated activations or deactivations of the same logic input does not influence the playing of the current MP3 file. Only the activation of a different logic input stops the current MP3 being played and activates the first MP3 file in the new playlist.

6.7 MPLL=13: Standard playlist

Operating mode as MPLL=11 except:

- Repeated activations or deactivations of the same logic input does not influence the playing of the current playlist. Only the activation of a different logic input stops the current MP3 being played and activates the new playlist.

6.8 MPLL=14: Stop & Play Restart playlist

Operating mode as MPLL=10 except:

- When the same logic input is reactivated the current MP3 file is restarted. The activation of a different logic input stops the current MP3 being played and activates the first MP3 file in the new playlist.

6.9 MPLL=15: Restart playlist

Operating mode as MPLL=11 except:

- When the same logic input is reactivated the playlist restarts from the beginning. The activation of a different logic input stops the current MP3 being played and activates the new playlist.

OPERATION WITH LOGIC INPUTS

7.1 Logic input operating mode

The DMA1 can also play individual MP3 audio files with direct selection from eight logic inputs (par. 3.4). The DMA1 enters this working mode if there are no PALIN.TXT and PLAYLIST.TXT files present.

Activation is carried out directly or in binary combination, up to a maximum of 255 files, using the logic inputs IN1, IN2, IN3, IN4, IN5, IN6, IN7 and IN8.

The play modes are set through the IMOD, TPCM, MICP and MIRS parameters inserted in the configuration files (par. 4.7).

7.2 Binary input command codes

Activating the logic inputs in binary combination allows the playing of up to 255 messages, named according to the audio files as shown in the following table.

INPUT								RELEVANT FILES / MESSAGES	
1	2	3	4	5	6	7	8	=	File.mp3
0	0	0	0	0	0	0	0	=	Standby
1	0	0	0	0	0	0	0	=	1.mp3 individual activation input IN1
0	1	0	0	0	0	0	0	=	2.mp3 individual activation input IN2
1	1	0	0	0	0	0	0	=	3.mp3 binary combination inputs IN1 + IN2
0	0	1	0	0	0	0	0	=	4.mp3 individual activation input IN3
1	0	1	0	0	0	0	0	=	5.mp3 binary combination inputs IN1 + IN3
0	1	1	0	0	0	0	0	=	6.mp3 binary combination inputs IN2 + IN3
1	1	1	0	0	0	0	0	=	7.mp3 binary combination inputs IN1 + IN2 + IN3
0	0	0	1	0	0	0	0	=	8.mp3 individual activation input IN4
1	0	0	1	0	0	0	0	=	9.mp3 binary combination inputs IN1 + IN4
0	1	0	1	0	0	0	0	=	10.mp3 binary combination inputs IN2 + IN4
1	1	0	1	0	0	0	0	=	11.mp3 binary combination inputs IN1 + IN2 + IN4
0	0	1	1	0	0	0	0	=	12.mp3 binary combination inputs IN3 + IN4
1	0	1	1	0	0	0	0	=	13.mp3 binary combination inputs IN1 + IN3 + IN4
0	1	1	1	0	0	0	0	=	14.mp3 binary combination inputs IN2 + IN3 + IN4
1	1	1	1	0	0	0	0	=	15.mp3 binary combination inputs IN1 + IN2 + IN3 + IN4
0	0	0	0	1	0	0	0	=	16.mp3 individual activation input IN5
1	0	0	0	1	0	0	0	=	17.mp3
0	1	0	0	1	0	0	0	=	18.mp3
1	1	0	0	1	0	0	0	=	19.mp3
0	0	1	0	1	0	0	0	=	20.mp3
1	0	1	0	1	0	0	0	=	21.mp3
0	1	1	0	1	0	0	0	=	22.mp3
1	1	1	0	1	0	0	0	=	23.mp3
0	0	0	1	1	0	0	0	=	24.mp3
1	0	0	1	1	0	0	0	=	25.mp3

OPERATION WITH LOGIC INPUTS

INPUT								RELEVANT FILES / MESSAGES	
1	2	3	4	5	6	7	8	=	File.mp3
0	1	0	1	1	0	0	0	=	26.mp3
1	1	0	1	1	0	0	0	=	27.mp3
0	0	1	1	1	0	0	0	=	28.mp3
1	0	1	1	1	0	0	0	=	29.mp3
0	1	1	1	1	0	0	0	=	30.mp3
1	1	1	1	1	0	0	0	=	31.mp3
0	0	0	0	0	1	0	0	=	32.mp3 individual activation input IN6
1	0	0	0	0	1	0	0	=	33.mp3
0	1	0	0	0	1	0	0	=	34.mp3
1	1	0	0	0	1	0	0	=	35.mp3
0	0	1	0	0	1	0	0	=	36.mp3
1	0	1	0	0	1	0	0	=	37.mp3
0	1	1	0	0	1	0	0	=	38.mp3
1	1	1	0	0	1	0	0	=	39.mp3
0	0	0	1	0	1	0	0	=	40.mp3
1	0	0	1	0	1	0	0	=	41.mp3
0	1	0	1	0	1	0	0	=	42.mp3
1	1	0	1	0	1	0	0	=	43.mp3
0	0	1	1	0	1	0	0	=	44.mp3
1	0	1	1	0	1	0	0	=	45.mp3
0	1	1	1	0	1	0	0	=	46.mp3
1	1	1	1	0	1	0	0	=	47.mp3
0	0	0	0	1	1	0	0	=	48.mp3
1	0	0	0	1	1	0	0	=	49.mp3
0	1	0	0	1	1	0	0	=	50.mp3
1	1	0	0	1	1	0	0	=	51.mp3
0	0	1	0	1	1	0	0	=	52.mp3
1	0	1	0	1	1	0	0	=	53.mp3
0	1	1	0	1	1	0	0	=	54.mp3
1	1	1	0	1	1	0	0	=	55.mp3
0	0	0	1	1	1	0	0	=	56.mp3
1	0	0	1	1	1	0	0	=	57.mp3
0	1	0	1	1	1	0	0	=	58.mp3
1	1	0	1	1	1	0	0	=	59.mp3
0	0	1	1	1	1	0	0	=	60.mp3
1	0	1	1	1	1	0	0	=	61.mp3
0	1	1	1	1	1	0	0	=	62.mp3
1	1	1	1	1	1	0	0	=	63.mp3
0	0	0	0	0	0	1	0	=	64.mp3 individual activation input IN7
1	0	0	0	0	0	1	0	=	65.mp3
0	1	0	0	0	0	1	0	=	66.mp3
1	1	0	0	0	0	1	0	=	67.mp3
0	0	1	0	0	0	1	0	=	68.mp3
1	0	1	0	0	0	1	0	=	69.mp3
0	1	1	0	0	0	1	0	=	70.mp3
1	1	1	0	0	0	1	0	=	71.mp3

OPERATION WITH LOGIC INPUTS

INPUT								RELEVANT FILES / MESSAGES	
1	2	3	4	5	6	7	8	=	File.mp3
0	0	0	1	0	0	1	0	=	72.mp3
1	0	0	1	0	0	1	0	=	73.mp3
0	1	0	1	0	0	1	0	=	74.mp3
1	1	0	1	0	0	1	0	=	75.mp3
0	0	1	1	0	0	1	0	=	76.mp3
1	0	1	1	0	0	1	0	=	77.mp3
0	1	1	1	0	0	1	0	=	78.mp3
1	1	1	1	0	0	1	0	=	79.mp3
0	0	0	0	1	0	1	0	=	80.mp3
1	0	0	0	1	0	1	0	=	81.mp3
0	1	0	0	1	0	1	0	=	82.mp3
1	1	0	0	1	0	1	0	=	83.mp3
0	0	1	0	1	0	1	0	=	84.mp3
1	0	1	0	1	0	1	0	=	85.mp3
0	1	1	0	1	0	1	0	=	86.mp3
1	1	1	0	1	0	1	0	=	87.mp3
0	0	0	1	1	0	1	0	=	88.mp3
1	0	0	1	1	0	1	0	=	89.mp3
0	1	0	1	1	0	1	0	=	90.mp3
1	1	0	1	1	0	1	0	=	91.mp3
0	0	1	1	1	0	1	0	=	92.mp3
1	0	1	1	1	0	1	0	=	93.mp3
0	1	1	1	1	0	1	0	=	94.mp3
1	1	1	1	1	0	1	0	=	95.mp3
0	0	0	0	0	1	1	0	=	96.mp3
1	0	0	0	0	1	1	0	=	97.mp3
0	1	0	0	0	1	1	0	=	98.mp3
1	1	0	0	0	1	1	0	=	99.mp3
0	0	1	0	0	1	1	0	=	100.mp3
1	0	1	0	0	1	1	0	=	101.mp3
0	1	1	0	0	1	1	0	=	102.mp3
1	1	1	0	0	1	1	0	=	103.mp3
0	0	0	1	0	1	1	0	=	104.mp3
1	0	0	1	0	1	1	0	=	105.mp3
0	1	0	1	0	1	1	0	=	106.mp3
1	1	0	1	0	1	1	0	=	107.mp3
0	0	1	1	0	1	1	0	=	108.mp3
1	0	1	1	0	1	1	0	=	109.mp3
0	1	1	1	0	1	1	0	=	110.mp3
1	1	1	1	0	1	1	0	=	111.mp3
0	0	0	0	1	1	1	0	=	112.mp3
1	0	0	0	1	1	1	0	=	113.mp3
0	1	0	0	1	1	1	0	=	114.mp3
1	1	0	0	1	1	1	0	=	115.mp3
0	0	1	0	1	1	1	0	=	116.mp3
1	0	1	0	1	1	1	0	=	117.mp3

OPERATION WITH LOGIC INPUTS

INPUT								RELEVANT FILES / MESSAGES	
1	2	3	4	5	6	7	8	=	File.mp3
0	1	1	0	1	1	1	0	=	118.mp3
1	1	1	0	1	1	1	0	=	119.mp3
0	0	0	1	1	1	1	0	=	120.mp3
1	0	0	1	1	1	1	0	=	121.mp3
0	1	0	1	1	1	1	0	=	122.mp3
1	1	0	1	1	1	1	0	=	123.mp3
0	0	1	1	1	1	1	0	=	124.mp3
1	0	1	1	1	1	1	0	=	125.mp3
0	1	1	1	1	1	1	0	=	126.mp3
1	1	1	1	1	1	1	0	=	127.mp3
0	0	0	0	0	0	0	1	=	128.mp3
1	0	0	0	0	0	0	1	=	129.mp3
0	1	0	0	0	0	0	1	=	130.mp3
1	1	0	0	0	0	0	1	=	131.mp3
0	0	1	0	0	0	0	1	=	132.mp3
1	0	1	0	0	0	0	1	=	133.mp3
0	1	1	0	0	0	0	1	=	134.mp3
1	1	1	0	0	0	0	1	=	135.mp3
0	0	0	1	0	0	0	1	=	136.mp3
1	0	0	1	0	0	0	1	=	137.mp3
0	1	0	1	0	0	0	1	=	138.mp3
1	1	0	1	0	0	0	1	=	139.mp3
0	0	1	1	0	0	0	1	=	140.mp3
1	0	1	1	0	0	0	1	=	141.mp3
0	1	1	1	0	0	0	1	=	142.mp3
1	1	1	1	0	0	0	1	=	143.mp3
0	0	0	0	1	0	0	1	=	144.mp3
1	0	0	0	1	0	0	1	=	145.mp3
0	1	0	0	1	0	0	1	=	146.mp3
1	1	0	0	1	0	0	1	=	147.mp3
0	0	1	0	1	0	0	1	=	148.mp3
1	0	1	0	1	0	0	1	=	149.mp3
0	1	1	0	1	0	0	1	=	150.mp3
1	1	1	0	1	0	0	1	=	151.mp3
0	0	0	1	1	0	0	1	=	152.mp3
1	0	0	1	1	0	0	1	=	153.mp3
0	1	0	1	1	0	0	1	=	154.mp3
1	1	0	1	1	0	0	1	=	155.mp3
0	0	1	1	1	0	0	1	=	156.mp3
1	0	1	1	1	0	0	1	=	157.mp3
0	1	1	1	1	0	0	1	=	158.mp3
1	1	1	1	1	0	0	1	=	159.mp3
0	0	0	0	0	1	0	1	=	160.mp3
1	0	0	0	0	1	0	1	=	161.mp3
0	1	0	0	0	1	0	1	=	162.mp3
1	1	0	0	0	1	0	1	=	163.mp3

individual activation input IN8

OPERATION WITH LOGIC INPUTS

INPUT								RELEVANT FILES / MESSAGES	
1	2	3	4	5	6	7	8	=	File.mp3
0	0	1	0	0	1	0	1	=	164.mp3
1	0	1	0	0	1	0	1	=	165.mp3
0	1	1	0	0	1	0	1	=	166.mp3
1	1	1	0	0	1	0	1	=	167.mp3
0	0	0	1	0	1	0	1	=	168.mp3
1	0	0	1	0	1	0	1	=	169.mp3
0	1	0	1	0	1	0	1	=	170.mp3
1	1	0	1	0	1	0	1	=	171.mp3
0	0	1	1	0	1	0	1	=	172.mp3
1	0	1	1	0	1	0	1	=	173.mp3
0	1	1	1	0	1	0	1	=	174.mp3
1	1	1	1	0	1	0	1	=	175.mp3
0	0	0	0	1	1	0	1	=	176.mp3
1	0	0	0	1	1	0	1	=	177.mp3
0	1	0	0	1	1	0	1	=	178.mp3
1	1	0	0	1	1	0	1	=	179.mp3
0	0	1	0	1	1	0	1	=	180.mp3
1	0	1	0	1	1	0	1	=	181.mp3
0	1	1	0	1	1	0	1	=	182.mp3
1	1	1	0	1	1	0	1	=	183.mp3
0	0	0	1	1	1	0	1	=	184.mp3
1	0	0	1	1	1	0	1	=	185.mp3
0	1	0	1	1	1	0	1	=	186.mp3
1	1	0	1	1	1	0	1	=	187.mp3
0	0	1	1	1	1	0	1	=	188.mp3
1	0	1	1	1	1	0	1	=	189.mp3
0	1	1	1	1	1	0	1	=	190.mp3
1	1	1	1	1	1	0	1	=	191.mp3
0	0	0	0	0	0	1	1	=	192.mp3
1	0	0	0	0	0	1	1	=	193.mp3
0	1	0	0	0	0	1	1	=	194.mp3
1	1	0	0	0	0	1	1	=	195.mp3
0	0	1	0	0	0	1	1	=	196.mp3
1	0	1	0	0	0	1	1	=	197.mp3
0	1	1	0	0	0	1	1	=	198.mp3
1	1	1	0	0	0	1	1	=	199.mp3
0	0	0	1	0	0	1	1	=	200.mp3
1	0	0	1	0	0	1	1	=	201.mp3
0	1	0	1	0	0	1	1	=	202.mp3
1	1	0	1	0	0	1	1	=	203.mp3
0	0	1	1	0	0	1	1	=	204.mp3
1	0	1	1	0	0	1	1	=	205.mp3
0	1	1	1	0	0	1	1	=	206.mp3
1	1	1	1	0	0	1	1	=	207.mp3
0	0	0	0	1	0	1	1	=	208.mp3
1	0	0	0	1	0	1	1	=	209.mp3

OPERATION WITH LOGIC INPUTS

INPUT								RELEVANT FILES / MESSAGES	
1	2	3	4	5	6	7	8	=	File.mp3
0	1	0	0	1	0	1	1	=	210.mp3
1	1	0	0	1	0	1	1	=	211.mp3
0	0	1	0	1	0	1	1	=	212.mp3
1	0	1	0	1	0	1	1	=	213.mp3
0	1	1	0	1	0	1	1	=	214.mp3
1	1	1	0	1	0	1	1	=	215.mp3
0	0	0	1	1	0	1	1	=	216.mp3
1	0	0	1	1	0	1	1	=	217.mp3
0	1	0	1	1	0	1	1	=	218.mp3
1	1	0	1	1	0	1	1	=	219.mp3
0	0	1	1	1	0	1	1	=	220.mp3
1	0	1	1	1	0	1	1	=	221.mp3
0	1	1	1	1	0	1	1	=	222.mp3
1	1	1	1	1	0	1	1	=	223.mp3
0	0	0	0	0	1	1	1	=	224.mp3
1	0	0	0	0	1	1	1	=	225.mp3
0	1	0	0	0	1	1	1	=	226.mp3
1	1	0	0	0	1	1	1	=	227.mp3
0	0	1	0	0	1	1	1	=	228.mp3
1	0	1	0	0	1	1	1	=	229.mp3
0	1	1	0	0	1	1	1	=	230.mp3
1	1	1	0	0	1	1	1	=	231.mp3
0	0	0	1	0	1	1	1	=	232.mp3
1	0	0	1	0	1	1	1	=	233.mp3
0	1	0	1	0	1	1	1	=	234.mp3
1	1	0	1	0	1	1	1	=	235.mp3
0	0	1	1	0	1	1	1	=	236.mp3
1	0	1	1	0	1	1	1	=	237.mp3
0	1	1	1	0	1	1	1	=	238.mp3
1	1	1	1	0	1	1	1	=	239.mp3
0	0	0	0	1	1	1	1	=	240.mp3
1	0	0	0	1	1	1	1	=	241.mp3
0	1	0	0	1	1	1	1	=	242.mp3
1	1	0	0	1	1	1	1	=	243.mp3
0	0	1	0	1	1	1	1	=	244.mp3
1	0	1	0	1	1	1	1	=	245.mp3
0	1	1	0	1	1	1	1	=	246.mp3
1	1	1	0	1	1	1	1	=	247.mp3
0	0	0	1	1	1	1	1	=	248.mp3
1	0	0	1	1	1	1	1	=	249.mp3
0	1	0	1	1	1	1	1	=	250.mp3
1	1	0	1	1	1	1	1	=	251.mp3
0	0	1	1	1	1	1	1	=	252.mp3
1	0	1	1	1	1	1	1	=	253.mp3
0	1	1	1	1	1	1	1	=	254.mp3
1	1	1	1	1	1	1	1	=	255.mp3

SPECIAL FUNCTIONS

8.1 Connection of two DMA1s

Connecting two DMA1s in cascade via the Vlink connection and the audio inputs/outputs (see figure), can recreate the typical operating mode of a commercial radio station.

One DMA1 must be programmed to run in playlist mode, playing the musical items (PLAYLISTS.TXT), the other DMA1 is programmed to run according to a schedule (PALIN.TXT) playing the commercials/spot announcements.

DMA1 with playlist

DMA1 with palimpsest

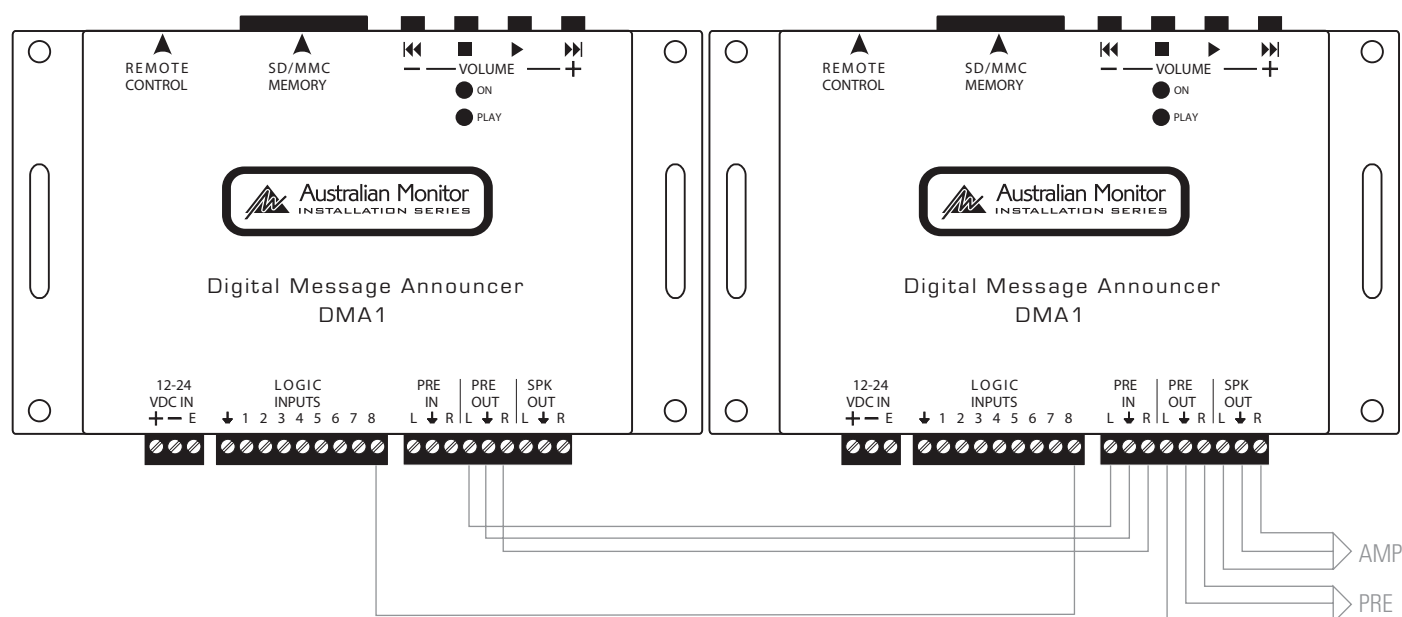

When a time event is to be played the schedule-programmed DMA1 waits for consent (the completion of playing the current MP3 music file) from playlist-programmed DMA1, (which goes into standby), before starting to play the commercials/spot announcements.

Once the playing of the time event is over, the playlist-programmed DMA1 will start to play the following MP3 music file in the playlist.

SPECIAL FUNCTIONS

8.2 Amplifier Bridging (40W)

The DMA1 has the capability of bridging the outputs of the stereo power amplifier to create a 40W bridge-mono configuration - to power a single 8ohm loudspeaker of greater power capacity.

To enable this operational mode, in addition to wiring the speaker in a bridged configuration, it is necessary to set the following parameters in the config.txt file:

OMON=1

INVR=1

OMON STEREO / MONO AUDIO OUTPUT SWITCH

OMON 0= STEREO audio output
 1= MONO audio output

INVR INVERTED RIGHT CHANNEL AUDIO OUTPUT SWITCH

INVR 0= right audio output channel not inverted (STEREO)
 1= right audio output channel inverted (BRIDGE-MONO configuration)

Panelplayer 20W + 20W STEREO

Panelplayer 40W MONO

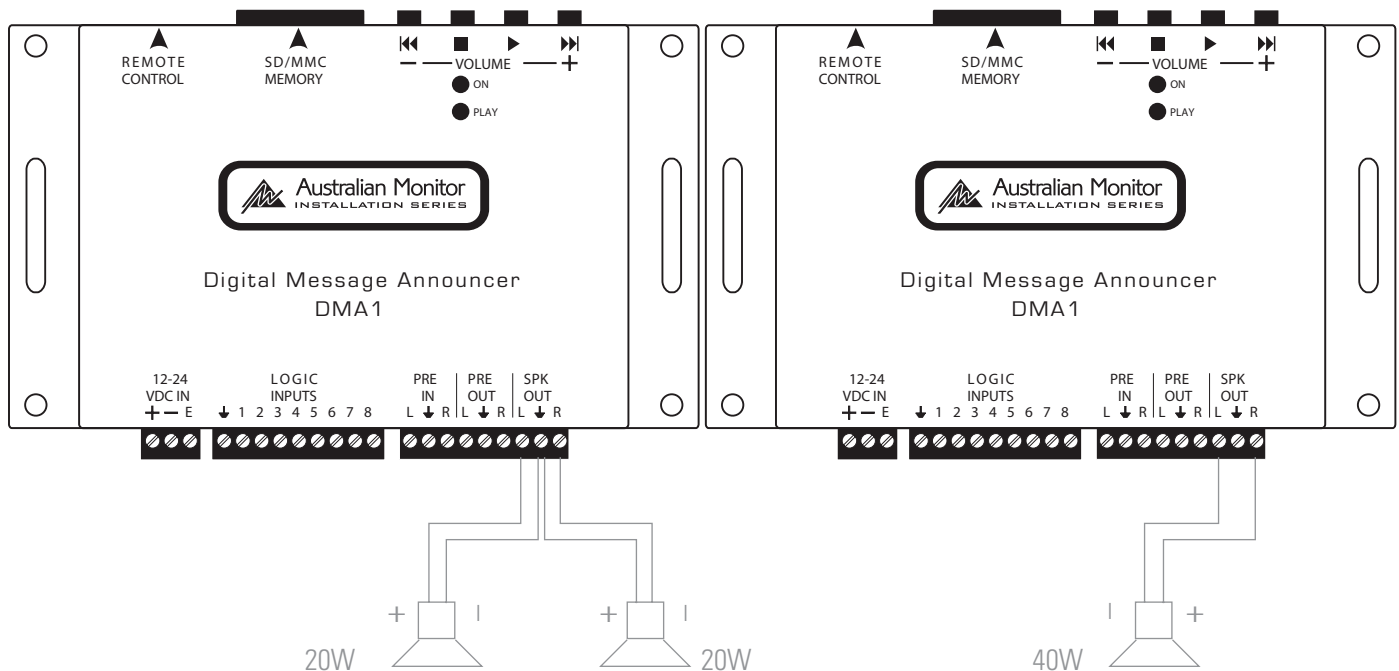

SERIAL RS485 COMMUNICATION

9.1 RS485 communication

The DMA1 can be connected to a Crestron control system or similar via RS485 serial connection.

Interference effects and induced noise on the serial line may cause anomalous behaviour and possible damage to the DMA1 unit. To avoid this, take the following precautions:

1. Do not let the serial cables transit the same conduits as power cables or cables with elevated voltage. Maintain a safe distance of at least 10 cm. between these cables
2. Connect the serial cable screen to the ground of one of the RS485 devices (do not connect the screen at both ends)
3. Disconnect power from the DMA1 and control system before wiring the serial control lines

The DMA1 supports up to 4 different RS485 modes of operation, according to the RS485 electrical standard. This serial multipoint communication supports the connection of up to 32 devices, with a maximum bus distance of 50 metres.

The DMA1 devices connected to the RS485 bus can not autonomously begin communication, but can respond to a specific request (command) from a control system.

The RS485 connection parameters (speed, parity, check-sum, etc.) are set in the configuration file config.txt. (par. 9.2).



IMPORTANT!

- The internal electronics of DMA1 are not galvanically insulated from the RS485 line; in case of short circuit or discharge to ground, it is possible to damage not only the DMA1, but the control system to which it is connected!
- The control system must remember to ignore the transmission echo from the control system that is returned through the RS485 serial line.



IMPORTANT!

- To enable the serial port through the IN5/485A and IN6/485B pins, remove the cover of the device and move the P1 and P2 jumpers, as indicated in the following figure.
- With an RS485 connection termination resistors must be applied on both extremes of the serial line to avoid the generation of stationary waves and to define the impedance of the serial line - even in absence of serial communications. The DMA1 features internal termination resistors, enabled through a JP1 bridge jumper. To deactivate the terminating resistors, remove the cover of the device and remove the JP1 jumper indicated in the following figure.

SERIAL RS485 COMMUNICATION

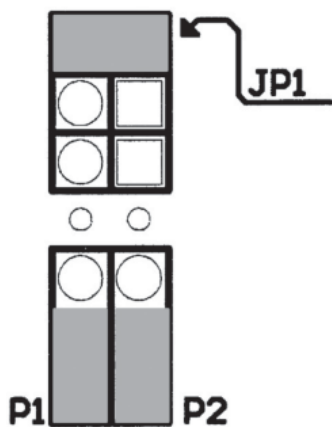
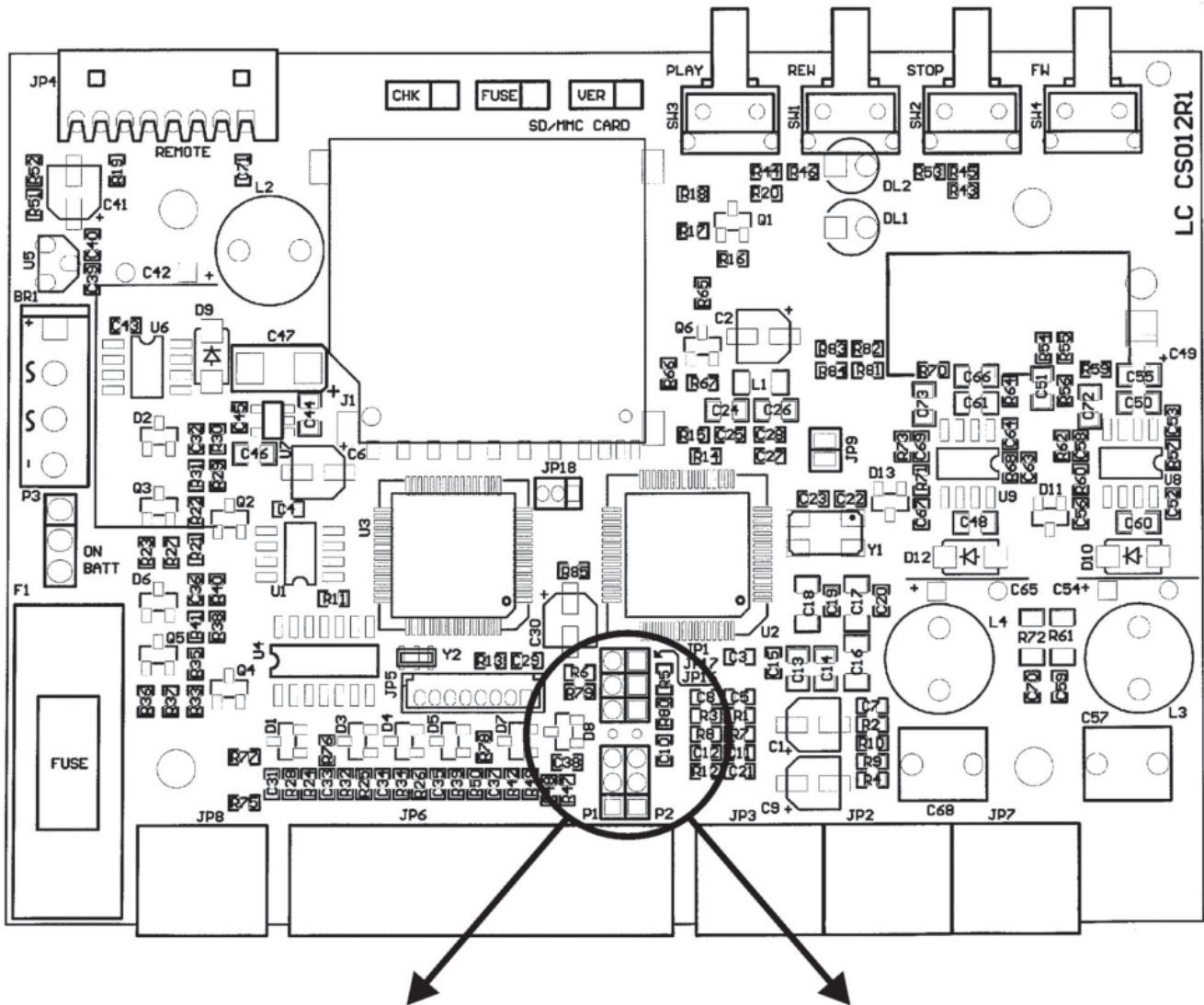

Position P1 and P2 jumpers: IN5 and IN6 inputs with logic operation. (Default)

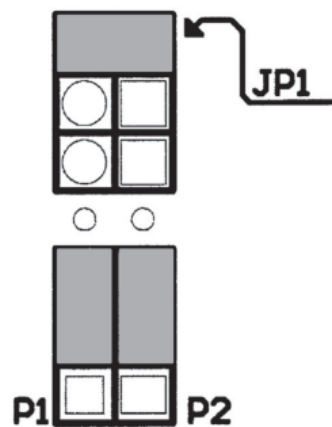

Position P1 and P2 jumpers: IN5 and IN6 inputs enabled to the operation as RS485 serial port. To move the bridges, remove the cover of the device and move the jumpers of the board as indicated in the figure

SERIAL RS485 COMMUNICATION

9.2 Serial port communication parameters (config.txt)

The parameters of the RS485 serial port (length of the packets, parity, speed, etc.) are set in the configuration file config.txt.

These parameters must be compatible with the external control system to which DMA1 is connected.

IMPORTANT!

To make changes to the communication parameters active, it is necessary to power-cycle the DMA1 after having inserting a flash memory card with the updated config.txt file.



IMPORTANT! notes for the control system

The DMA1 is ready for serial communication instructions under the following conditions:

- When DMA1 is turned on
- When the previous communication instruction has been completed
- When the timeout time for the last received/transmitted packet has expired

The following table lists the values and parameters needed to connect the DMA1 to a control system (protocol, speed, timings, etc.).

MNEMONIC	DESCRIPTION
CMAD	DMA1 address in the RS485 bus (ADD) (Value between 0 and 31 in decimal). IMPORTANT! This address MUST be unique; two devices with the same address can not co-exist on the same bus.
CMCK	Enabling of Checksum: 0=Checksum deactivated 1=Checksum activated
CMCL	Enabling inclusion of end-of-packet characters CR and LF (hexadecimal values 0D and 0A) 0=No CR and LF 1=Insertion of CR and LF active
CMBR	Baud rate (communication speed in bits per second) 0=1200 bps 1=2400 bps 2=4800 bps 3=9600 bps
CMPR	Parity Bits: 0=no parity 1=odd parity 2=even parity
CMSB	Number of Stop Bits 1=1 StopBit 2=2 StopBits
CMDB	Number of data bits 7=7 bits per datum 8=8 bits per datum
CMDR	Minimum delay between end of reception a packet and delivery of the reply. (Value expressed in tens of 1msec between 0 and 15 in decimal) 0=Minimum delay of 4msec 1=Minimum delay of 10msec 2=Minimum delay of 20msec

SERIAL RS485 COMMUNICATION

Reply wait time (CMDR)

This is the delay time before the transmission of a reply message, required by some control systems to switch between the state of transmission and the state of reception.

The reply waiting time determines the minimum delay before the DMA1 sends data in reply to the message received from the control system. Set this time at a value different from 0 only if the control system requires it, since the delay determines an extension of the time needed to complete the command.

9.3 "Framing" error

A framing error may take place if nothing is being transmitted on the serial line.

In order to avoid this mishap, it is recommended that the control system ignores all data until it has received one of the STX, ACK or NAK characters coming from a DMA1.

9.4 NAK reply by a DMA1

The reply with the NAK character is sent from DMA1 to the control system when any kind of error is detected in the received message.

9.5 Transmitting a command from a control system

When sending a command from the control system to a DMA1, make sure it is sent after a minimum delay of 10ms after receiving the last instruction from the DMA1 to ensure the DMA1 has had sufficient time to process the last request.

! IMPORTANT!

When using an RS485 bus remember to ignore the echo of the command that is sent from the control system (with RS485 an echo is always present).

9.6 Basic format of dedicated protocols

The DMA1 supports up to four dedicated RS485 protocols.

Which of these four protocols is used by the serial connection is defined in the configuration file config.txt (par. 9.2).

The difference between these four formats is due to the presence or absence of CheckSum and/or of the end-of-packet characters CR (Carriage Return, character 0DH) and LF (Line Feed, character 0AH).

9.7 Basic set-up of data packets

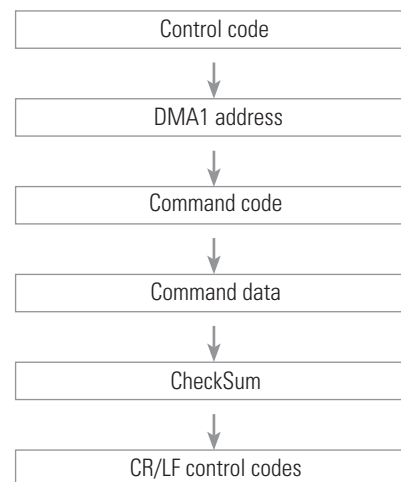

SERIAL RS485 COMMUNICATION

IMPORTANT!

The introduction of CheckSum at the end of the block of data and characters of CR + LF is defined in the configuration file config.txt (par. 9.2).

9.8 Control codes

The control codes are characters (they belong to the first 32 ASCII characters and cannot be printed out) which define the type of information contained in the packet following them.

The control codes used are those which appear on the following table.

The DMA1 initialises serial communications when it receives the character ENQ.

MNEMONIC	CODE	DESCRIPTION
STX	02H	Start TeXt. Beginning of reply packet
ETX	03H	End TeXt. End of reply packet
ENQ	05H	EnQuiry. Beginning of packet addressed to DMA1
ACK	06H	ACKnowledged. Beginning of reply packet: all OK!
LF	0AH	Line Feed. End of line code
CR	0DH	Carriage Return
NAK	15H	Not ACKnowledged. Beginning of reply packet: ERROR!

9.9 Address (ADD)

The address is a unique number that allows the control system to establish communication with one of the various modules connected to the same serial communications line.

The DMA1 address is defined in the configuration file config.txt (par. 9.2).

IMPORTANT!

When setting the address it is necessary to be careful to not define more than one DMA1 with the same address, otherwise the communication becomes confused and irregular.

The address can assume any value between 00H and 1FH.

The address is expressed in ASCII characters and consists of 2 characters.

9.10 Command (CMD)

CMD (command) is used to define an operation to be carried out (for example PLAY, reading the state or setting of the volume). Commands are defined as ASCII characters and consist of 2 characters.

In the following sections of this chapter a list of commands (and detail about each command) will be provided.

SERIAL RS485 COMUNICATION

9.11 CheckSum (CHK)

CheckSum ensures that packets are complete and not corrupted during transmission by any noise or interference induced on the RS485 bus.

The CheckSum is calculated summing the hexadecimal values of the ASCII characters contained in the data packet (excluding the control code). The two least significant characters (in hexadecimal) of the result represent the CheckSum value, and are added to the end of the packet (before any CR and LF characters).

 NOTE: CheckSum is enabled by the CMCK parameter of the configuration file config.txt.

- If CMCK=1, CheckSum will be calculated automatically and added to the reply packet (any packet beginning 'STX'). When a packet is received, the DMA1 calculates the CheckSum of the received packet locally and compares it with the one contained in the packet itself. If the calculated CheckSum is identical to the received CheckSum the DMA1 perform the command, otherwise an error packet is transmitted (packet beginning with 'NAK').
- If CMCK=0, CheckSum will not be appended to transmitted packets and will not be compared (also because it is missing in the data) in the received packets.

The following figure shows an example of the calculation of a CheckSum in a command packet delivered by the control system

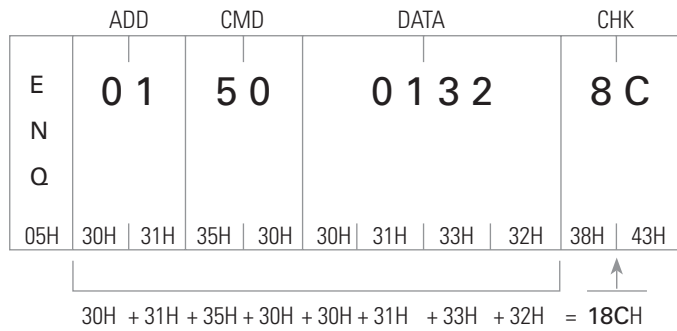

SERIAL RS485 COMMUNICATION

9.12 Basic protocol

Reading the data of the DMA1 from the control system

Transmission sequence

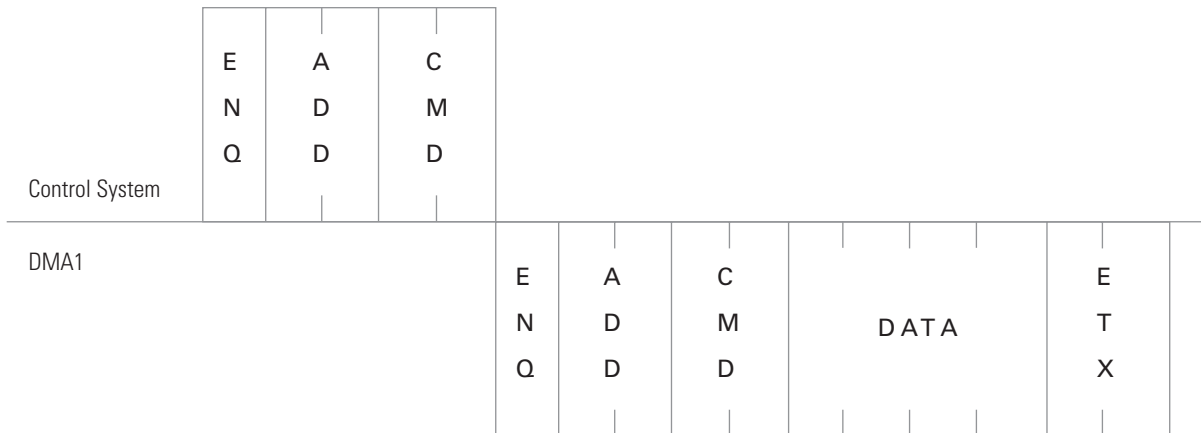

Sending a command to the DMA1 from the Control System

Transmission sequence

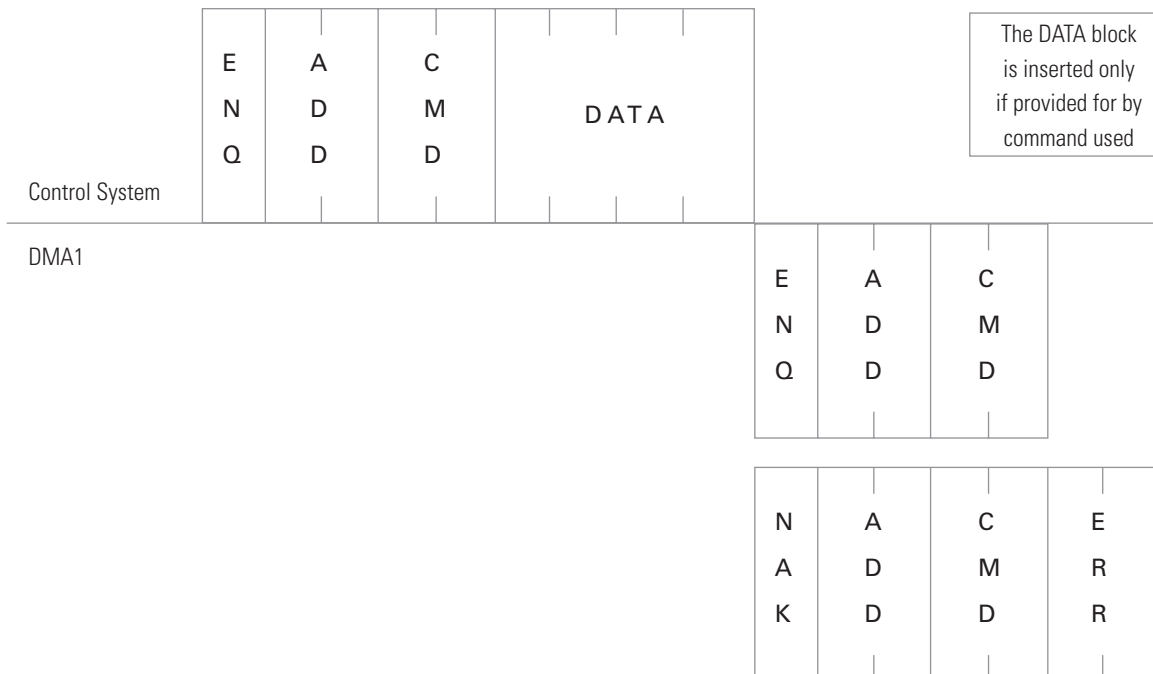

SERIAL RS485 COMMUNICATION

9.13 Basic protocol with CheckSum

Reading the data of the DMA1 from the control system

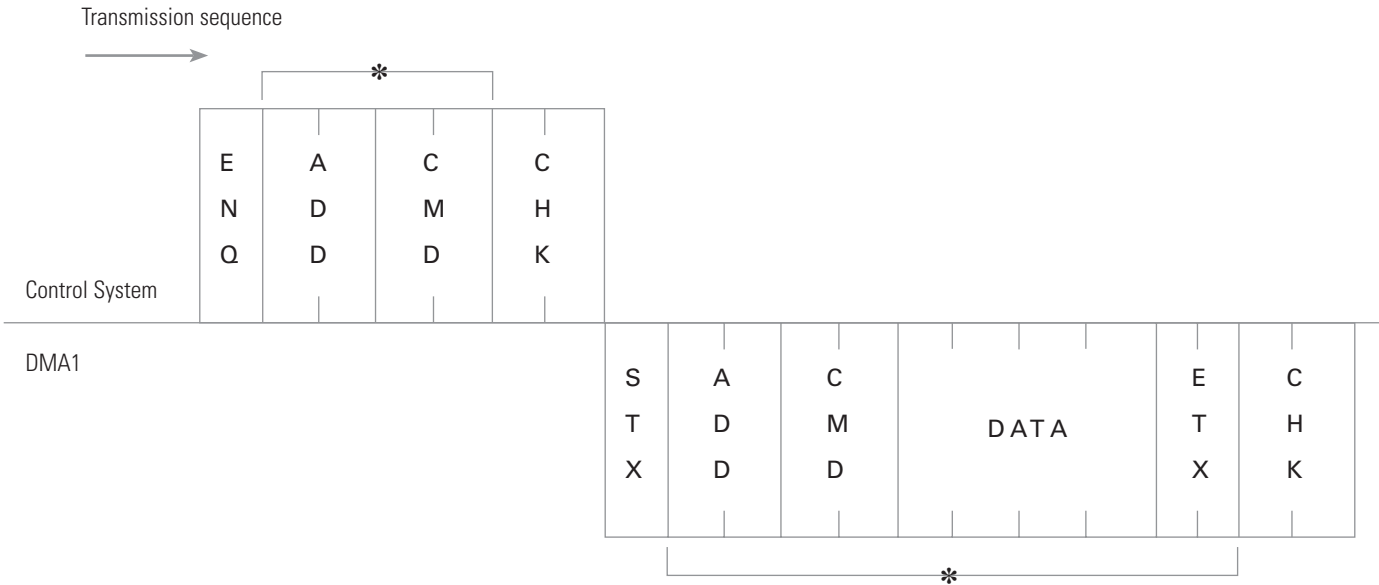

Sending a command to the DMA1 from the Control System



- * 1. The CheckSum is introduced if the configuration parameter CMCK=1.
- 2. The CheckSum is calculated summing all the characters marked by an asterisk.

SERIAL RS485 COMMUNICATION

9.14 Basic protocol with CR and LF

Reading the data of the DMA1 from the control system

Transmission sequence

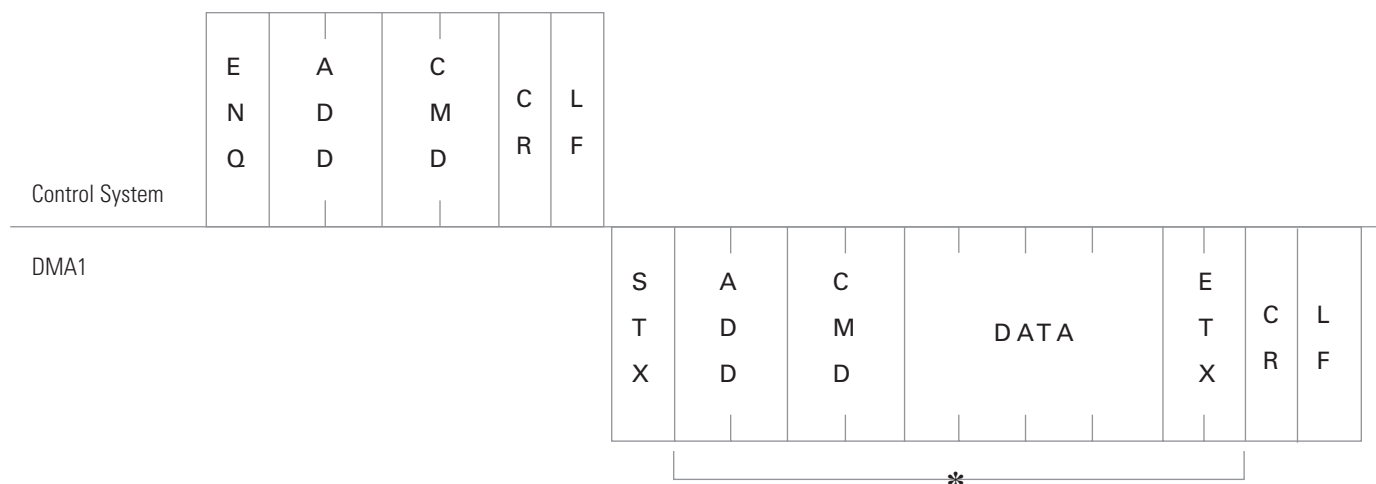

Sending a command to the DMA1 from the Control System

Transmission sequence

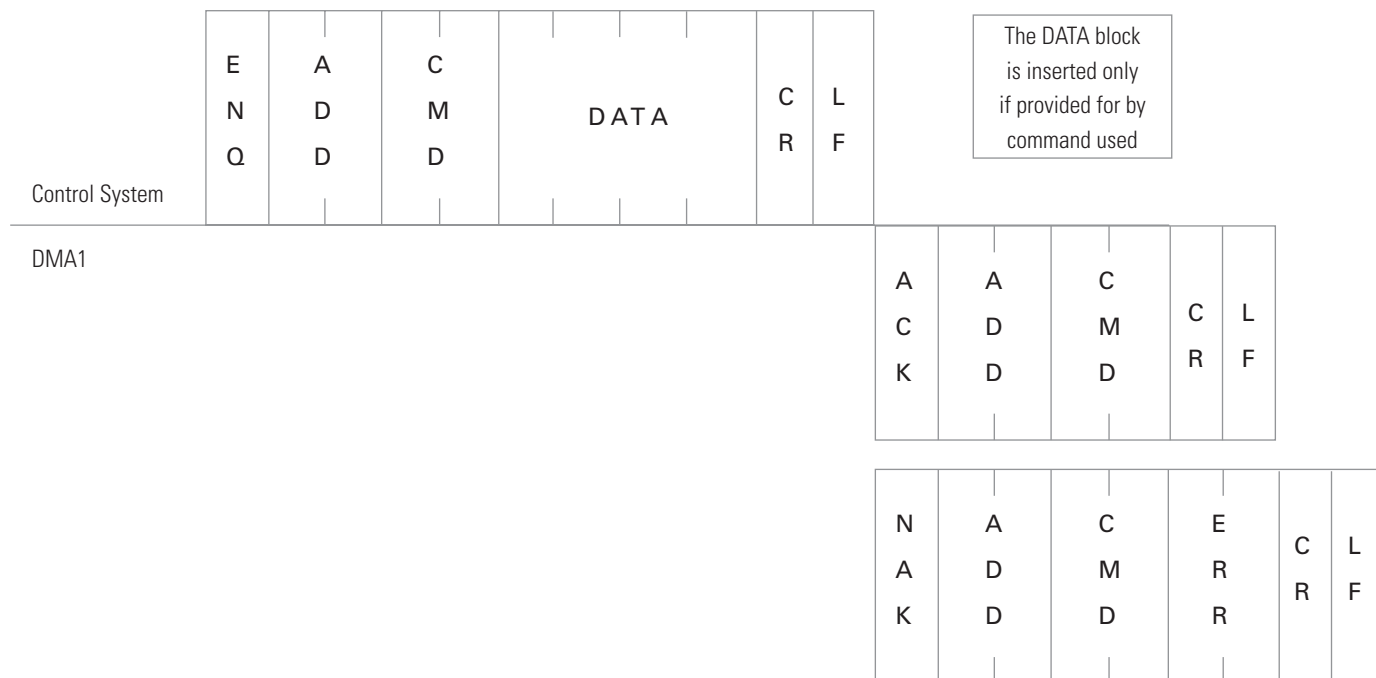

SERIAL RS485 COMMUNICATION

9.15 Basic protocol with CheckSum, CR and LF

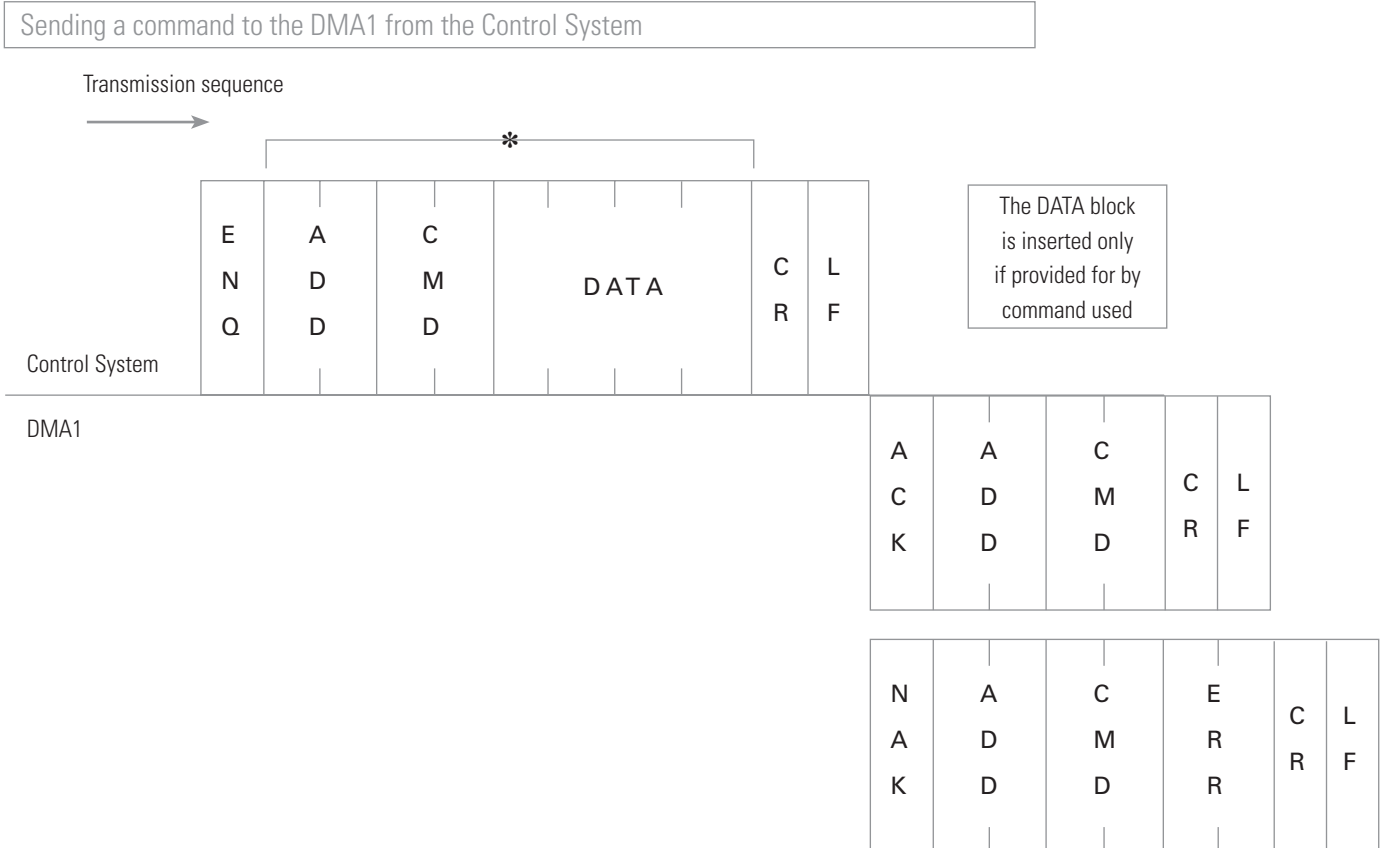
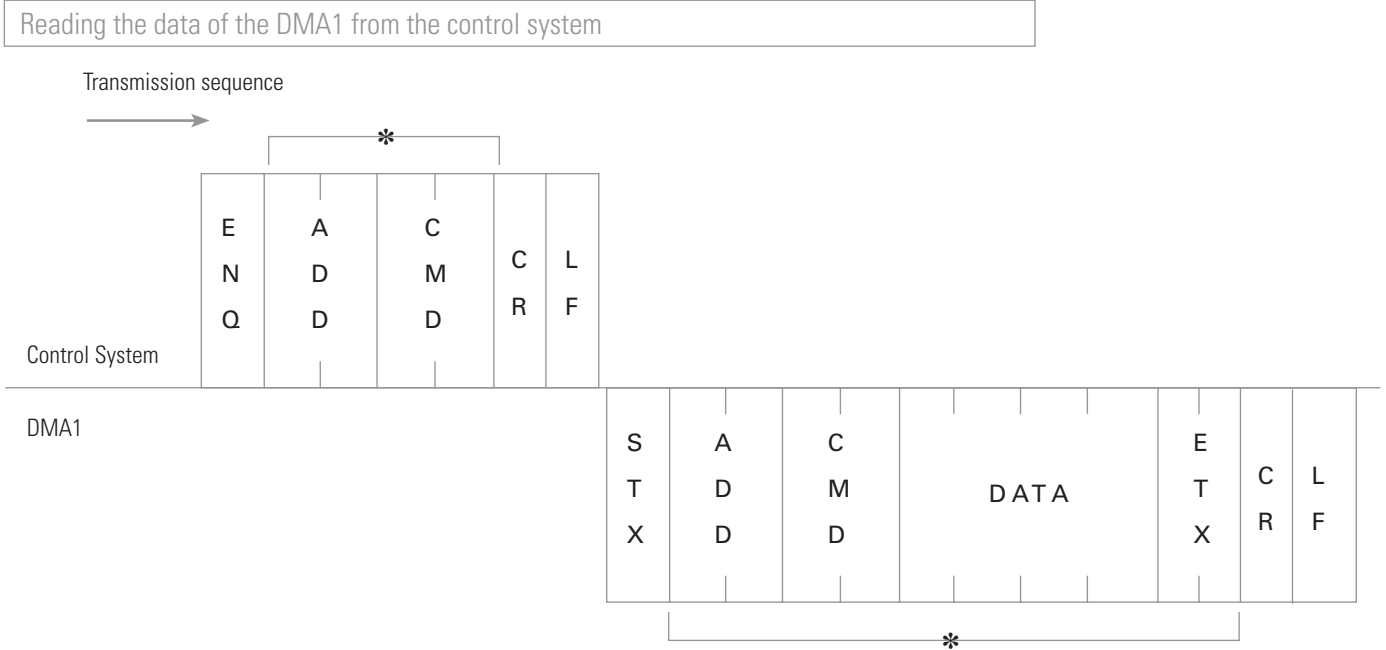

- * 1. The CheckSum is introduced if the configuration parameter CMCK=1.
- 2. The CheckSum is calculated summing all the characters marked by an asterisk.

SERIAL RS485 COMMUNICATION

9.16 List of commands and operating fields

This table provides a list, with the relevant comments, of all the commands managed by the DMA1.

DESCRIPTION	CMD	COMMAND DATA	REPLY DATA
STATUS request	30	None	a b c d a = State of the player: S = Stop P = Play b = (reserved) c = (reserved) d = (reserved)
STOP	31	None	None
PLAY First	32	None	None
PLAY Next	33	None	None
PLAY Prior	34	None	None
PLAY File	50	Name of file without extension (4 characters only)	None
PLAY File 2 (automatic STOP before PLAY)	51	Name of file without extension (4 characters only)	None
SET Volume	52	Level in hexadecimal (0..14H)	None
SET Treble tone control	53	Level in hexadecimal (0..14H)	None
SET Bass tone control	54	Level in hexadecimal (0..14H)	None
SET Loudness	55	Level in hexadecimal (0..14H)	None
Version of firmware	35	None	P = DMA1 x = version xx = Release Version
State of inputs	37	None	a b c d e f g h a = IN/OUT 7 b = IN/OUT 8 c = IN 6 d = IN 5 e = IN 4 f = IN 3 g = IN 2 h = IN 1
Flash memory size	38	None	Size of the flash (MAX. 4 characters)
Title of item being played	39	None	Title of the item (MAX. 12 characters)

SERIAL RS485 COMUNICATION

9.17 Error codes

The following table lists all the error codes which the DMA1 delivers together with the NAK packet if problems are found.

CODE	DESCRIPTION
10H	Failure to convert command code (CMD). It could contain characters which are outside the representation of a hexadecimal value. The permitted values are: 'a'..'f' 'A' 'F' '0'....'9'
11H	Failure to convert the value contained in 'DATA' into a number. It could contain characters which are outside the representation of a hexadecimal value. The permitted values are: 'a'..'f' 'A' 'F' '0'....'9'
12H	Failure to convert the CheckSum (CHK). It could contain characters which are outside the representation of a hexadecimal value. The permitted values are: 'a'..'f' 'A' 'F' '0'....'9'
13H	Checksum wrong
14H	Reserved error
20H	Wrong value in the parameter of the command SET_Volume. It could be more than the maximum permitted value
21H	Wrong value in the parameter of the command SET_Treble. It could be more than the maximum permitted value
22H	Wrong value in the parameter of the command SET_Bass. It could be more than the maximum permitted value
23H	Wrong value in the parameter of the command SET_Loudness. It could be more than the maximum permitted value
30H	The command PLAY cannot be processed because the flash memory is missing
31H	The command PLAY (excluding PLAY File 2) cannot be processed because DMA1 is already playing. To solve the problem, first send the command STOP, or else use the command PLAY_File_2 which automatically stops any file being played
32H	The file requested via the command PLAY_File or PLAY_File_2 has not been found. The four characters inserted as an argument for these commands must correspond exactly to the name of the file intend to play, except for the extension. E.g.: the command ENQ + 00501234 requires the playing of the file 1234.mp3 on DMA1 with address 00
33H	Failure to play the requested file. The file could be corrupt

SPECIFICATIONS

POWER SUPPLY	12-15VAC or 12-24VDC
CONSUMPTION IN STANDBY	1 W
PROTECTION	internal fuse, 4A delayed
CAPACITY OF EXTRACTABLE MEMORY	SD/MMC from 32MB to 1GB
INPUT ABSORPTION	5 mA
FORMATS ACCEPTED	MPEG1 layer 3 (file MP3 from 64 to 160 Kbps)
FREQUENCY RESPONSE	20 ~ 20.000 Hz (± 3 dB)
SIGNAL/NOISE RATIO	> 90dB
HARMONIC DISTORTION	< 0.1%
OUTPUT POWER	20+20W (24V / 4 Ω) THD= 0.04%
AUDIO CONTROLS	<ul style="list-style-type: none"> - General output volume control - Control of input volume and background level with mixer function - Separate bass and treble tone controls - Loudness level control - Automatic fade in - Automatic fade out
CONTROL KEYS	4 buttons REW, PLAY, STOP, FWD and menu functions
CLASSIFICATION	IP30 on the basis of liquid and dust penetration
SIZE	102x102x19mm

10.2 Maintenance and conservation

See par. 2.2

10.3 Disposal

To safeguard the environment, the device and its accessories must be disposed of according to legal requirements, in properly equipped places or as special waste.

If you do not know the legal requirements, please contact the dealer or the manufacturer.

SERIAL NO. A

Power 12-24VDC 2A



Product compliant with the safeguard regulations 73/23/EEC, 89/336/EEC and 93/68/EEC about electromagnetic safety and compatibility.

AUSTRALIA AND NEW ZEALAND

www.australianmonitor.com.au

SYDNEY

(NSW & ACT SALES)

149 Beaconsfield
Street Silverwater
NSW 2128
Private Bag 149
Silverwater NSW 1811
Phone: (02) 9647 1411
Fax: (02) 9648 3698
Email:
nsw@audiotelx.com.au

MELBOURNE

(VIC & TAS SALES)

22/277
Middleborough Road
Box Hill VIC 3128
PO Box 151 Blackburn
South VIC 3130
Phone: (03) 9890 7477
Fax: (03) 9890 7977
Email:
vic@audiotelx.com.au

BRISBANE

(QLD SALES)

42 Commercial Road
Fortitude Valley
QLD 4006
PO Box 871 Fortitude
Valley QLD 4006
Phone: (07) 3852 1312
Fax: (07) 3252 1237
Email:
qld@audiotelx.com.au

ADELAIDE

(SA & NT SALES)

31 Walsh Street
Thebarton
SA 5031
PO Box 157
Hindmarsh SA 5007
Phone: (08) 8352 4444
Fax: (08) 8352 4488
Email:
sa@audiotelx.com.au

PERTH

(WA SALES)

299 Fitzgerald Street
West Perth WA 6005
PO Box 404
North Perth
WA 6906
Phone: (08) 9228 4222
Fax: (08) 9228 4233
Email:
wa@audiotelx.com.au

AUCKLAND

(NZ SALES)

Unit B, 11 Piermark
Drive Albany 1331
New Zealand
PO Box 512
Albany 1331
Phone: (09) 415 9426
Fax: (09) 415 9864
Email:
sales@audiotelx.co.nz

EUROPE / ASIA / MIDDLE EAST

www.australianmonitor.com.au

INTERNATIONAL SALES

149 Beaconsfield Street Silverwater NSW 2128 Australian
Private Bag 149 Silverwater NSW 1811
Phone: (02) 9647 1411
Fax: (02) 9648 3698
Email: international@audiotelx.com.au